

IF03

3" ROUND RECESSED

Spectrum's Infinium 3" recessed round downlight series features multiple housings and variety of trims for accent and general illumination.

NOMINAL LUMENS / WATTAGE DATA				
PART NUMBER	CCT RANGE	DELIVERED LUMENS ¹	SYSTEM WATTS	LPW
IF03RMF 007 PC	835	537	7	73
IF03RMF 010 PC	835	751	9	81
IF03RMF 015 PC	835	1046	12	86
IF03RMF 020 PC	835	1341	15	89
IF03RMF 030 PC	835	2012	20.4	99

¹ Nominal Delivered Lumens at 835 DL FLGP MW at DD1 020 DL FL GP MW

PROJECT: _____
 QUANTITY: _____ TYPE: _____



PRODUCT SELECTOR GUIDE

SERIES	TYPE	EMITTER	CRI/CCT	LUMENS	OPTIONS	DIMMING	MOUNTING	BATTERY	TRIM	BEAM	LENS	FINISH	FLANGE FINISH	OPTIONS	ADDITIONAL ACCESSORIES
IF03RMF	NC	PC	835	10		N11	B1		DL	SP	GN	MW	MF	WL	GRIF03R

FIXTURE HOUSING SPECIFICATION

SERIES	TYPE	EMITTER	CRI / CCT	LUMENS	OPTIONS	DIMMING	MOUNTING	BATTERY	
SHALLOW		PC	90 Minimum	07 537 Lm	PR 1.25" Ceiling Extension	N1 Non-Dimming Electronic Driver D1 1%, 0-10V	1 120V 2 277V	E1 7W Integral Battery ER 7W Remote Battery	
IF03RMF	Flange		NC New Construction	10 751 Lm					B1 Expandable Bar Hangers
			IC New Construction	15 1046 Lm					
			RT Remodel Construction	20 ³ 1341 Lm					
			80 CRI	30 ³ 2012 Lm					
SUPER SHALLOW		IC	827 2700K	BO No Bar Hangers					
IF03RSF ¹	Flange		830 3000K						
			835 3500K						
			840 4000K						

¹ IF03RSF are only available in IC ² 822 Not Available with 30L ³ Not Available with IF03RSF
⁴ E1 is not available with IF03RSF

AVAILABLE TRIM / MODULE TYPES



TRIM / MODULE SPECIFICATION

TRIM	BEAM	LENS	FINISH	FLANGE FINISH ⁹	OPTIONS
DL Downlight	SP Spot (24°)	GN ⁸ No Lens	MW Matte White	MF Matching Flange	WL ¹¹ Wet Location
PH Pinhole Downlight	NF Narrow Flood (28°)	GP Solite™ Micro Prism Lens	MB Matte Black	WF ¹⁰ White Flange	
	FL Flood (38°)	GC Clear Glass Lens	PT Platinum Silver		
	WF Wide Flood (61°)		CC Custom Color		
AA Adjustable Accent	NF Narrow Flood (35°)				
	FL Flood (43°)				
	WF Wide Flood (48°)				
WW Wall Wash	WF Wide Flood	LW Wall Wash Lens			

⁸ Not Available in Wet Location ⁹ Not Available with PH Trim 10 For Use with Non-White Trim Finish ¹¹ Requires GP or GC Lens

SEPARATE

ADDITIONAL ACCESSORIES	
GOOF RING	
GRIF03R	MW Matte White
	MB Matte Black
	PT Platinum Silver
	CC Custom Color
BAR HANGERS	
B2	27" Solid Bar Hangers
B4	24" C-Channel Bar Hangers

GREEN TEXT INDICATES QUICK SHIP OPTIONS

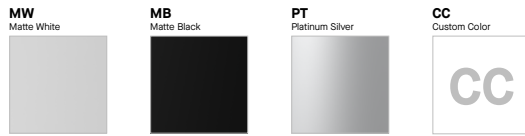

FINISH**PRODUCT FEATURES**

- Versatile shallow plenum 3" round recessed LED luminaire features downlight, adjustable accent, wall wash and pinhole downlight trim options with new construction, insulated ceiling and retrofit housings.
- Two-stage optical systems for smooth light distribution and focus control. Tool-less driver and j-box access. "Posi-lock" trim retention springs. All frames are capable of installation in ceiling thicknesses from 1/16" to 1" thick.

Trim Finish

- A variety of architectural trim finish options utilizing powdercoat colors. Matte White flange is an option for non-white finishes

Electronics

- LED module features high brightness Philips LEDs. 3-step MacAdam Ellipse binning and 80 and 90 CRI available. 0-10V or phase-cut dimming to 1%, standard. Variety of 120V/277V drivers available, consult factory. 2200K closely resembles candle light or high pressure sodium lamps.
- Variety of electronic 120/277V and Dimming options are available. Emergency backup version available as standard option.

Construction

- Housing/frame constructed of #20 ga. galvanized steel to resist corrosion. Self-flanged one piece die-cast aluminum trim is finished to specification. Passive machined aluminum heatsink.

Code Compliance

- ETL certified to meet US and Canadian standards. Suitable for dry or damp locations. Optional Wet Location. Manufactured and tested to UL standards No. 1598/8750. Insulated Ceiling (IC) options available.
- Designed, manufactured, and assembled in Fall River, MA, BAA compliant.
- Recyclable materials utilized wherever possible.

Quick Ship

- Quick Ship highlights products that can ship in 3 - 5 working days.

HOUSING DIMENSIONS

IF03RMF NC - New Construction

Non-IC rated, thermally protected frame-in kit for new construction. Non-IC designation requires insulation must be minimum of 3" from housing.

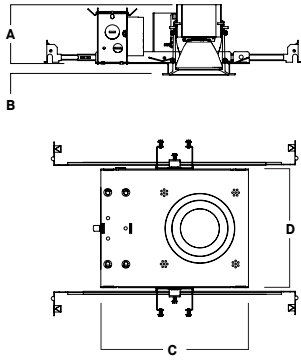

A	B	C	D
4.5	.625	9.5	7.6
114.3 mm	15.9 mm	241.3 mm	193.0 mm

Fixture Weight: 4.0 lbs

Ceiling Cutout: Ø 3"™

IF03RMF IC - IC New Construction

IC rated frame-in kit for new construction with direct insulation contact.

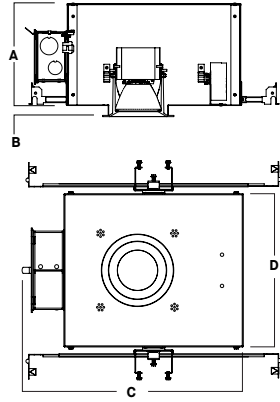

A	B	C	D
6.5	.625	13.2	9.5
165.1 mm	15.9 mm	335.3 mm	241.3 mm

Fixture Weight: 5.0 lbs

Ceiling Cutout: Ø 3"™

IF03RSF IC - Super Shallow IC New Construction

IC rated frame-in kit for new construction with direct insulation contact.

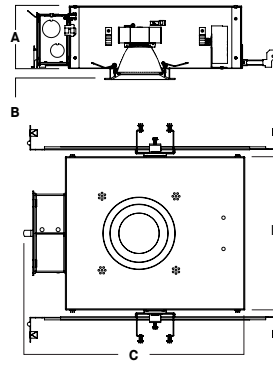

A	B	C	D
4.0	.625	13.2	9.5
101.6 mm	15.9 mm	335.3 mm	241.3 mm

Fixture Weight: 5.0 lbs

Ceiling Cutout: Ø 3"™

IF03RMF RT - Remodel Construction

Non-IC rated frame-in kit for existing construction. Non-IC designation requires insulation must be minimum of 3" from housing.

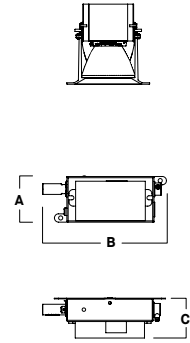

A	B	C
2.8	7.5	2.4
71.1 mm	190.5 mm	61.0 mm

Fixture Weight: 2.0 lbs

Ceiling Cutout: Ø 3"™

EMERGENCY BATTERY

EM - 3" EM Option

EM requires above ceiling access, supplied with remote mounted test switch. Not available in IC Housing.

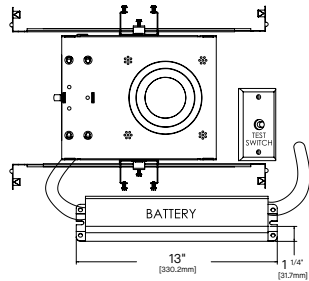

ADDITIONAL ACCESSORIES

GRIF03R - 3" Round Goof Ring

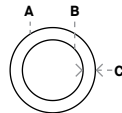

A	B	C
Ø 5.3	Ø 3.7	0.8
134.6 mm	94.0 mm	20.3 mm

OPTICS

SP - Spot (24°)



NF - Narrow Flood (28°)



FL - Flood (38°)



WF - Wide Flood (61°)



AA - Adjustable Accent



WW - Wall Wash



TRIM / MODULE DIMENSIONS

30L SHALLOW HOUSING (IF03RMF) TRIMS

DL - Downlight Shallow Flange

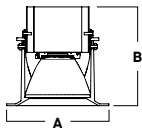

A	B
4.5	4.6
114.3 mm	116.8 mm

PH - Pinhole Flange

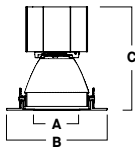

A	B	C
2.0	4.5	4.8
50.8 mm	114.3 mm	121.9 mm

AA - 30° Adjustable Shallow Flange

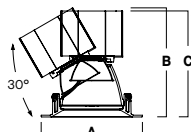

A	B	C
4.5	5.0	4.9
114.3 mm	127.0 mm	124.5 mm

WW - Wall Wash Flange

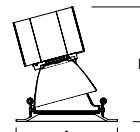

A	B
4.5	5.2
114.3 mm	132.1 mm

07L - 20L SHALLOW HOUSING (IF03RMF) TRIMS & SUPER SHALLOW HOUSING (IF03RSF) TRIMS

DL - Downlight Shallow Flange

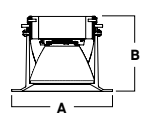

A	B
4.5	3.6
114.3 mm	91.4 mm

PH - Pinhole Flange

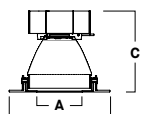

A	B	C
2.0	4.5	3.8
50.8 mm	114.3 mm	96.5 mm

AA - 30° Adjustable Shallow Flange

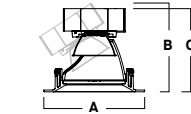

A	B	C
4.5	4.0	3.9
114.3 mm	101.6 mm	99.1 mm

WW - Wall Wash Flange

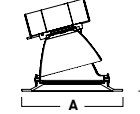

A	B
4.5	4.1
114.3 mm	104.1 mm

IF03RMx xx 835 020 DLSPGP MW - Shallow

CANDLEPOWER CURVE TEST SP-00760_2	INTENSITY CANDELA 0° AZIMUTH	ZONAL LUMENS	SINGLE UNIT: PERFORMANCE DIRECT FOOTCANDLES BASED ON DOWNLIGHT ONLY	MULTIPLE UNITS: PERFORMANCE 80/50/20% REFLECTANCES INITIAL FOOTCANDLES AND WATTS PER SQUARE FOOT																																	
	0°	0° - 10° 356 26%	Mounting Height AFF	<table border="1"> <thead> <tr> <th>FC at Center on Floor</th> <th>Beam Diameter</th> <th>FC at Beam Edge</th> </tr> </thead> <tbody> <tr> <td>8' 74 fc</td> <td>3.4'</td> <td>35 fc</td> </tr> <tr> <td>10' 47 fc</td> <td>4.2'</td> <td>22 fc</td> </tr> <tr> <td>12' 33 fc</td> <td>5.1'</td> <td>15 fc</td> </tr> <tr> <td>14' 24 fc</td> <td>5.9'</td> <td>11 fc</td> </tr> <tr> <td>16' 18 fc</td> <td>6.8'</td> <td>9 fc</td> </tr> <tr> <td>20' 12 fc</td> <td>8.4'</td> <td>6 fc</td> </tr> <tr> <td>24' 8 fc</td> <td>10.1'</td> <td>4 fc</td> </tr> <tr> <td>28' 6 fc</td> <td>11.8'</td> <td>3 fc</td> </tr> </tbody> </table>	FC at Center on Floor	Beam Diameter	FC at Beam Edge	8' 74 fc	3.4'	35 fc	10' 47 fc	4.2'	22 fc	12' 33 fc	5.1'	15 fc	14' 24 fc	5.9'	11 fc	16' 18 fc	6.8'	9 fc	20' 12 fc	8.4'	6 fc	24' 8 fc	10.1'	4 fc	28' 6 fc	11.8'	3 fc						
	FC at Center on Floor	Beam Diameter	FC at Beam Edge																																		
	8' 74 fc	3.4'	35 fc																																		
	10' 47 fc	4.2'	22 fc																																		
	12' 33 fc	5.1'	15 fc																																		
	14' 24 fc	5.9'	11 fc																																		
	16' 18 fc	6.8'	9 fc																																		
	20' 12 fc	8.4'	6 fc																																		
	24' 8 fc	10.1'	4 fc																																		
	28' 6 fc	11.8'	3 fc																																		
	0° 4733	0° - 20° 832 61%	8' 74 fc	3.4'	35 fc																																
5° 4195	0° - 30° 1145 84%	10' 47 fc	4.2'	22 fc																																	
15° 1707	0° - 40° 1285 94%	12' 33 fc	5.1'	15 fc																																	
25° 675	0° - 60° 1340 98%	14' 24 fc	5.9'	11 fc																																	
35° 211	0° - 80° 1363 100%	16' 18 fc	6.8'	9 fc																																	
45° 36	0° - 90° 1364 100%	20' 12 fc	8.4'	6 fc																																	
55° 24	Total 1365 100%	24' 8 fc	10.1'	4 fc																																	
90° 1		28' 6 fc	11.8'	3 fc																																	
		<table border="1"> <thead> <tr> <th>Ceiling Height</th> <th>Fixture Spacing</th> <th colspan="2">RCR 4</th> <th colspan="2">RCR 6</th> </tr> <tr> <td></td> <td></td> <th>FC *</th> <th>W/Sq. Ft.</th> <th>FC *</th> <th>W/Sq. Ft.</th> </tr> </thead> <tbody> <tr> <td>18'</td> <td>4'</td> <td>68</td> <td>0.81</td> <td>63</td> <td>0.82</td> </tr> <tr> <td>22'</td> <td>6'</td> <td>34</td> <td>0.40</td> <td>28</td> <td>0.36</td> </tr> <tr> <td>26'</td> <td>8'</td> <td>18</td> <td>0.21</td> <td>19</td> <td>0.25</td> </tr> </tbody> </table>		Ceiling Height	Fixture Spacing	RCR 4		RCR 6				FC *	W/Sq. Ft.	FC *	W/Sq. Ft.	18'	4'	68	0.81	63	0.82	22'	6'	34	0.40	28	0.36	26'	8'	18	0.21	19	0.25	<table border="1"> <thead> <tr> <th>Delivered Illuminance Rating: (DIR)</th> <td>84 FC per W/Sq. Ft.</td> <td>77 FC per W/Sq. Ft.</td> </tr> </thead> </table>	Delivered Illuminance Rating: (DIR)	84 FC per W/Sq. Ft.	77 FC per W/Sq. Ft.
Ceiling Height	Fixture Spacing	RCR 4		RCR 6																																	
		FC *	W/Sq. Ft.	FC *	W/Sq. Ft.																																
18'	4'	68	0.81	63	0.82																																
22'	6'	34	0.40	28	0.36																																
26'	8'	18	0.21	19	0.25																																
Delivered Illuminance Rating: (DIR)	84 FC per W/Sq. Ft.	77 FC per W/Sq. Ft.																																			
Recessed mounting Square rooms used for multiple units: RCR 4: Length & Width = Ceiling Ht. - 2.5' x 2.50 RCR 6: Length & Width = Ceiling Ht. - 2.5' x 1.66 * Average Footcandles at 2.5' Above Floor																																					

Delivered Lumens: 1365
Luminaire Watts: 15
LER: 91.00

CP at 0° (Nadir): 4733
CRI: 80

Beam Angle: 24°
Spacing Ratio: 0.40

Lumen Multiplier: 07L x 0.40, 10L x 0.56, 15L x 0.78
CCT Multiplier: 40K x 1.03

IF03RMx xx 835 020 DLNFGP MW - Shallow

CANDLEPOWER CURVE TEST SP-00759_2	INTENSITY CANDELA 0° AZIMUTH	ZONAL LUMENS	SINGLE UNIT: PERFORMANCE DIRECT FOOTCANDLES BASED ON DOWNLIGHT ONLY	MULTIPLE UNITS: PERFORMANCE 80/50/20% REFLECTANCES INITIAL FOOTCANDLES AND WATTS PER SQUARE FOOT																																	
	0°	0° - 10° 315 23%	Mounting Height AFF	<table border="1"> <thead> <tr> <th>FC at Center on Floor</th> <th>Beam Diameter</th> <th>FC at Beam Edge</th> </tr> </thead> <tbody> <tr> <td>8' 60 fc</td> <td>4.1'</td> <td>27 fc</td> </tr> <tr> <td>10' 38 fc</td> <td>5.1'</td> <td>17 fc</td> </tr> <tr> <td>12' 26 fc</td> <td>6.1'</td> <td>12 fc</td> </tr> <tr> <td>14' 19 fc</td> <td>7.1'</td> <td>9 fc</td> </tr> <tr> <td>16' 15 fc</td> <td>8.1'</td> <td>7 fc</td> </tr> <tr> <td>20' 10 fc</td> <td>10.2'</td> <td>4 fc</td> </tr> <tr> <td>24' 7 fc</td> <td>12.2'</td> <td>3 fc</td> </tr> <tr> <td>28' 5 fc</td> <td>14.2'</td> <td>2 fc</td> </tr> </tbody> </table>	FC at Center on Floor	Beam Diameter	FC at Beam Edge	8' 60 fc	4.1'	27 fc	10' 38 fc	5.1'	17 fc	12' 26 fc	6.1'	12 fc	14' 19 fc	7.1'	9 fc	16' 15 fc	8.1'	7 fc	20' 10 fc	10.2'	4 fc	24' 7 fc	12.2'	3 fc	28' 5 fc	14.2'	2 fc						
	FC at Center on Floor	Beam Diameter	FC at Beam Edge																																		
	8' 60 fc	4.1'	27 fc																																		
	10' 38 fc	5.1'	17 fc																																		
	12' 26 fc	6.1'	12 fc																																		
	14' 19 fc	7.1'	9 fc																																		
	16' 15 fc	8.1'	7 fc																																		
	20' 10 fc	10.2'	4 fc																																		
	24' 7 fc	12.2'	3 fc																																		
	28' 5 fc	14.2'	2 fc																																		
	0° 3815	0° - 20° 801 59%	8' 60 fc	4.1'	27 fc																																
5° 3595	0° - 30° 1124 83%	10' 38 fc	5.1'	17 fc																																	
15° 1725	0° - 40° 1271 94%	12' 26 fc	6.1'	12 fc																																	
25° 669	0° - 60° 1324 98%	14' 19 fc	7.1'	9 fc																																	
35° 192	0° - 80° 1345 100%	16' 15 fc	8.1'	7 fc																																	
45° 35	0° - 90° 1347 100%	20' 10 fc	10.2'	4 fc																																	
55° 19	Total 1347 100%	24' 7 fc	12.2'	3 fc																																	
90° 1		28' 5 fc	14.2'	2 fc																																	
		<table border="1"> <thead> <tr> <th>Ceiling Height</th> <th>Fixture Spacing</th> <th colspan="2">RCR 3</th> <th colspan="2">RCR 5</th> </tr> <tr> <td></td> <td></td> <th>FC *</th> <th>W/Sq. Ft.</th> <th>FC *</th> <th>W/Sq. Ft.</th> </tr> </thead> <tbody> <tr> <td>14'</td> <td>6"</td> <td>32</td> <td>0.37</td> <td>36</td> <td>0.45</td> </tr> <tr> <td>18'</td> <td>8"</td> <td>18</td> <td>0.20</td> <td>20</td> <td>0.25</td> </tr> <tr> <td>22'</td> <td>10"</td> <td>15</td> <td>0.17</td> <td>12</td> <td>0.16</td> </tr> </tbody> </table>		Ceiling Height	Fixture Spacing	RCR 3		RCR 5				FC *	W/Sq. Ft.	FC *	W/Sq. Ft.	14'	6"	32	0.37	36	0.45	18'	8"	18	0.20	20	0.25	22'	10"	15	0.17	12	0.16	<table border="1"> <thead> <tr> <th>Delivered Illuminance Rating: (DIR)</th> <td>87 FC per W/Sq. Ft.</td> <td>79 FC per W/Sq. Ft.</td> </tr> </thead> </table>	Delivered Illuminance Rating: (DIR)	87 FC per W/Sq. Ft.	79 FC per W/Sq. Ft.
Ceiling Height	Fixture Spacing	RCR 3		RCR 5																																	
		FC *	W/Sq. Ft.	FC *	W/Sq. Ft.																																
14'	6"	32	0.37	36	0.45																																
18'	8"	18	0.20	20	0.25																																
22'	10"	15	0.17	12	0.16																																
Delivered Illuminance Rating: (DIR)	87 FC per W/Sq. Ft.	79 FC per W/Sq. Ft.																																			
Recessed mounting Square rooms used for multiple units: RCR 3: Length & Width = Ceiling Ht. - 2.5' x 3.33 RCR 5: Length & Width = Ceiling Ht. - 2.5' x 2.00 * Average Footcandles at 2.5' Above Floor ** Exceeds Spacing Ratio by 11% *** Exceeds Spacing Ratio by 9%																																					

Delivered Lumens: 1347
Luminaire Watts: 15
LER: 89.80

CP at 0° (Nadir): 3815
CRI: 80

Beam Angle: 28°
Spacing Ratio: 0.47

Lumen Multiplier: 07L x 0.40, 10L x 0.56, 15L x 0.78
CCT Multiplier: 40K x 1.03

IF03RMx xx 835 020 DLFLGP MW - Shallow

CANDLEPOWER CURVE TEST SP-00758_2	INTENSITY CANDELA 0° AZIMUTH	ZONAL LUMENS	SINGLE UNIT: PERFORMANCE DIRECT FOOTCANDLES BASED ON DOWNLIGHT ONLY	MULTIPLE UNITS: PERFORMANCE 80/50/20% REFLECTANCES INITIAL FOOTCANDLES AND WATTS PER SQUARE FOOT																																	
	0°	0° - 10° 236 18%	Mounting Height AFF	<table border="1"> <thead> <tr> <th>FC at Center on Floor</th> <th>Beam Diameter</th> <th>FC at Beam Edge</th> </tr> </thead> <tbody> <tr> <td>8' 42 fc</td> <td>5.5'</td> <td>18 fc</td> </tr> <tr> <td>10' 27 fc</td> <td>6.9'</td> <td>11 fc</td> </tr> <tr> <td>12' 19 fc</td> <td>8.3'</td> <td>8 fc</td> </tr> <tr> <td>14' 14 fc</td> <td>9.7'</td> <td>6 fc</td> </tr> <tr> <td>16' 11 fc</td> <td>11.0'</td> <td>4 fc</td> </tr> <tr> <td>20' 7 fc</td> <td>13.8'</td> <td>3 fc</td> </tr> <tr> <td>24' 5 fc</td> <td>16.6'</td> <td>2 fc</td> </tr> <tr> <td>28' 3 fc</td> <td>19.3'</td> <td>1 fc</td> </tr> </tbody> </table>	FC at Center on Floor	Beam Diameter	FC at Beam Edge	8' 42 fc	5.5'	18 fc	10' 27 fc	6.9'	11 fc	12' 19 fc	8.3'	8 fc	14' 14 fc	9.7'	6 fc	16' 11 fc	11.0'	4 fc	20' 7 fc	13.8'	3 fc	24' 5 fc	16.6'	2 fc	28' 3 fc	19.3'	1 fc						
	FC at Center on Floor	Beam Diameter	FC at Beam Edge																																		
	8' 42 fc	5.5'	18 fc																																		
	10' 27 fc	6.9'	11 fc																																		
	12' 19 fc	8.3'	8 fc																																		
	14' 14 fc	9.7'	6 fc																																		
	16' 11 fc	11.0'	4 fc																																		
	20' 7 fc	13.8'	3 fc																																		
	24' 5 fc	16.6'	2 fc																																		
	28' 3 fc	19.3'	1 fc																																		
	0° 2698	0° - 20° 712 53%	8' 42 fc	5.5'	18 fc																																
5° 2550	0° - 30° 1102 82%	10' 27 fc	6.9'	11 fc																																	
15° 1723	0° - 40° 1267 94%	12' 19 fc	8.3'	8 fc																																	
25° 852	0° - 60° 1321 98%	14' 14 fc	9.7'	6 fc																																	
35° 261	0° - 80° 1340 100%	16' 11 fc	11.0'	4 fc																																	
45° 38	0° - 90° 1341 100%	20' 7 fc	13.8'	3 fc																																	
55° 16	Total 1341 100%	24' 5 fc	16.6'	2 fc																																	
90° 1		28' 3 fc	19.3'	1 fc																																	
		<table border="1"> <thead> <tr> <th>Ceiling Height</th> <th>Fixture Spacing</th> <th colspan="2">RCR 3</th> <th colspan="2">RCR 5</th> </tr> <tr> <td></td> <td></td> <th>FC *</th> <th>W/Sq. Ft.</th> <th>FC *</th> <th>W/Sq. Ft.</th> </tr> </thead> <tbody> <tr> <td>14'</td> <td>6'</td> <td>32</td> <td>0.37</td> <td>35</td> <td>0.45</td> </tr> <tr> <td>18'</td> <td>8'</td> <td>17</td> <td>0.20</td> <td>19</td> <td>0.25</td> </tr> <tr> <td>22'</td> <td>10'</td> <td>11</td> <td>0.13</td> <td>12</td> <td>0.16</td> </tr> </tbody> </table>		Ceiling Height	Fixture Spacing	RCR 3		RCR 5				FC *	W/Sq. Ft.	FC *	W/Sq. Ft.	14'	6'	32	0.37	35	0.45	18'	8'	17	0.20	19	0.25	22'	10'	11	0.13	12	0.16	<table border="1"> <thead> <tr> <th>Delivered Illuminance Rating: (DIR)</th> <td>86 FC per W/Sq. Ft.</td> <td>77 FC per W/Sq. Ft.</td> </tr> </thead> </table>	Delivered Illuminance Rating: (DIR)	86 FC per W/Sq. Ft.	77 FC per W/Sq. Ft.
Ceiling Height	Fixture Spacing	RCR 3		RCR 5																																	
		FC *	W/Sq. Ft.	FC *	W/Sq. Ft.																																
14'	6'	32	0.37	35	0.45																																
18'	8'	17	0.20	19	0.25																																
22'	10'	11	0.13	12	0.16																																
Delivered Illuminance Rating: (DIR)	86 FC per W/Sq. Ft.	77 FC per W/Sq. Ft.																																			
Recessed mounting Square rooms used for multiple units: RCR 3: Length & Width = Ceiling Ht. - 2.5' x 3.33 RCR 5: Length & Width = Ceiling Ht. - 2.5' x 2.00 * Average Footcandles at 2.5' Above Floor																																					

Delivered Lumens: 1341
Luminaire Watts: 15
LER: 89.40

CP at 0° (Nadir): 2698
CRI: 80

Beam Angle: 38°
Spacing Ratio: 0.60

Lumen Multiplier: 07L x 0.40, 10L x 0.56, 15L x 0.78
CCT Multiplier: 40K x 1.03

IF03RMx xx 835 020 DLWFGP MW - Shallow

CANDLEPOWER CURVE TEST SP-00761_2	INTENSITY CANDELA 0° AZIMUTH	ZONAL LUMENS		SINGLE UNIT: PERFORMANCE DIRECT FOOTCANDLES BASED ON DOWNLIGHT ONLY				MULTIPLE UNITS: PERFORMANCE 80/50/20% REFLECTANCES INITIAL FOOTCANDLES AND WATTS PER SQUARE FOOT								
		0° - 10°	115	9%	Mounting Height AFF	FC at Center on Floor	Beam Diameter	FC at Beam Edge	Ceiling Height	Fixture Spacing	RCR 2		RCR 4			
	0°	1218	0° - 10°	115	9%	8'	19 fc	9.4'	6 fc	10'	6'	31	0.38	27	0.38	
	5°	1200	0° - 20°	418	34%	10'	12 fc	11.8'	4 fc	14'	8'	18	0.22	11	0.16	
	15°	1076	0° - 30°	800	65%	12'	8 fc	14.1'	3 fc	18'	10'	13	0.16	11	0.16	
	25°	858	0° - 40°	1044	85%	14'	6 fc	16.5'	2 fc	Delivered Illuminance Rating: (DIR)			81 FC per W/Sq. Ft.		70 FC per W/Sq. Ft.	
	35°	375	0° - 60°	1201	98%	16'	5 fc	18.9'	2 fc	Recessed mounting Square rooms used for multiple units: RCR 2: Length & Width = Ceiling Ht. - 2.5' x 5.00 RCR 4: Length & Width = Ceiling Ht. - 2.5' x 2.50 * Average Footcandles at 2.5' Above Floor						
	45°	128	0° - 80°	1227	100%	20'	3 fc	23.6'	1 fc							
	55°	56	0° - 90°	1228	100%	24'	2 fc	28.3'	1 fc							
	90°	1	Total	1228	100%	28'	2 fc	33.0'	0 fc							

Delivered Lumens: 1228
Luminaire Watts: 15
LER: 81.87

CP at 0° (Nadir): 1218
CRI: 80

Beam Angle: 61°
Spacing Ratio: 0.95

Lumen Multiplier: 07L x 0.40, 10L x 0.56, 15L x 0.78
CCT Multiplier: 40K x 1.03

IF03RMx xx PC 835 020 WW WF LW MW - Wall Wash, Shallow

CANDLEPOWER CURVE
TEST SP-00849

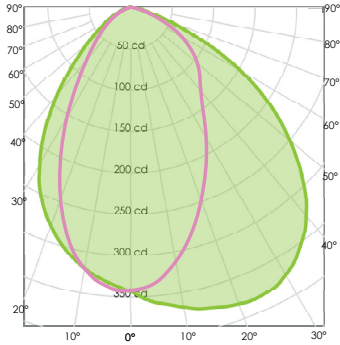

PERFORMANCE SUMMARY

Delivered Lumens: 598
 Luminaire Watts: 15
 LER: 39.87
 CP at 0deg (Nadir): 343
 CRI: 80+
 Lumen Multiplier: 07L x 0.40, 10L x 0.56, 15L x 0.78
 CCT Multiplier: 27K x 0.95, 30K x 0.98, 40K x 1.03

REFERENCE DIAGRAM

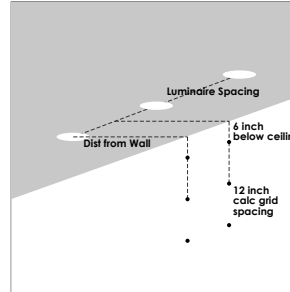

PERFORMANCE DATA - INITIAL ILLUMINATION (FOOTCANDLES) ON WALL - DIRECT LIGHT ONLY

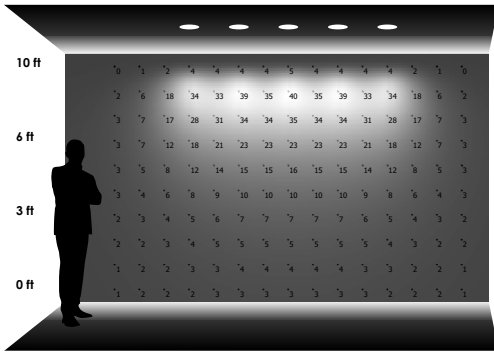

5 LUMINAIRES
2' away from wall
2' between luminaires

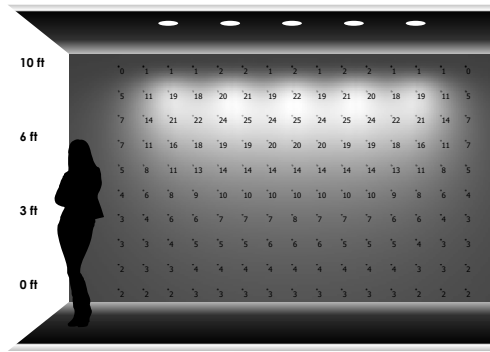

5 LUMINAIRES
2'-6" away from wall
2'-6" between luminaires



5 LUMINAIRES
3' away from wall
3' between luminaires

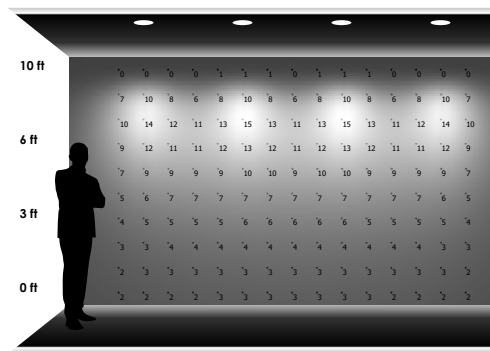

4 LUMINAIRES
3' away from wall
4' between luminaires

IF03RMx xx PC 835 030 DLSPGP MW - Shallow

CANDLEPOWER CURVE TEST SP-00760_2_M-30L	INTENSITY CANDELA 0° AZIMUTH	ZONAL LUMENS	SINGLE UNIT: PERFORMANCE DIRECT FOOTCANDLES BASED ON DOWNLIGHT ONLY	MULTIPLE UNITS: PERFORMANCE 80/50/20% REFLECTANCES INITIAL FOOTCANDLES AND WATTS PER SQUARE FOOT					
	0°	0° - 10° 534 26%	Mounting Height AFF	Ceiling Height	Fixture Spacing	RCR 4		RCR 6	
	0° 7100	0° - 20° 1248 61%	FC at Center on Floor	FC *	W/Sq. Ft.	FC *	W/Sq. Ft.	FC *	W/Sq. Ft.
	5° 6292	0° - 30° 1717 84%	Beam Diameter	18'	4'	103	1.10	94	1.11
	15° 2560	0° - 40° 1928 94%	FC at Beam Edge	22'	6'	51	0.55	41	0.49
	25° 1012	0° - 60° 2011 98%	10' 71 fc 4.2' 33 fc	26'	8'	27	0.29	28	0.34
	35° 317	0° - 80° 2044 100%	12' 49 fc 5.1' 23 fc	Delivered Illuminance Rating: (DIR)		93 FC per W/Sq. Ft.		85 FC per W/Sq. Ft.	
	45° 54	0° - 90° 2047 100%	14' 36 fc 5.9' 17 fc	Recessed mounting Square rooms used for multiple units: RCR 4: Length & Width = Ceiling Ht. - 2.5' x 2.50 RCR 6: Length & Width = Ceiling Ht. - 2.5' x 1.66 * Average Footcandles at 2.5' Above Floor					
	55° 37	Total 2047 100%	16' 28 fc 6.8' 13 fc						
	90° 1		20' 18 fc 8.4' 8 fc						
			24' 12 fc 10.1' 6 fc						
			28' 9 fc 11.8' 4 fc						
		32' 7 fc 13.5' 3 fc							

Delivered Lumens: 2047
Luminaire Watts: 20.4
LER: 100.34

CP at 0° (Nadir): 7100
CRI: 80

Beam Angle: 24°
Spacing Ratio: 0.40

Lumen Multiplier: N/A. 30L only
CCT Multiplier: 27K x 0.96, 30K x 0.98, 40K x 1.04
27HK x 0.87, 30HK x 0.81

IF03RMx xx PC 835 030 DLNFGP MW - Shallow

CANDLEPOWER CURVE TEST SP-00759_2_M-30L	INTENSITY CANDELA 0° AZIMUTH	ZONAL LUMENS	SINGLE UNIT: PERFORMANCE DIRECT FOOTCANDLES BASED ON DOWNLIGHT ONLY	MULTIPLE UNITS: PERFORMANCE 80/50/20% REFLECTANCES INITIAL FOOTCANDLES AND WATTS PER SQUARE FOOT					
	0°	0° - 10° 472 23%	Mounting Height AFF	Ceiling Height	Fixture Spacing	RCR 3		RCR 5	
	0° 5723	0° - 20° 1202 59%	FC at Center on Floor	FC *	W/Sq. Ft.	FC *	W/Sq. Ft.	FC *	W/Sq. Ft.
	5° 5392	0° - 30° 1685 83%	Beam Diameter	14'	6"	48	0.50	54	0.62
	15° 2587	0° - 40° 1907 94%	FC at Beam Edge	18'	8"	27	0.28	30	0.34
	25° 1004	0° - 60° 1986 98%	8' 89 fc 4.1' 41 fc	22'	10"	23	0.24	19	0.21
	35° 288	0° - 80° 2017 100%	10' 57 fc 5.1' 26 fc	Delivered Illuminance Rating: (DIR)		96 FC per W/Sq. Ft.		87 FC per W/Sq. Ft.	
	45° 52	0° - 90° 2020 100%	12' 40 fc 6.1' 18 fc	Recessed mounting Square rooms used for multiple units: RCR 3: Length & Width = Ceiling Ht. - 2.5' x 3.33 RCR 5: Length & Width = Ceiling Ht. - 2.5' x 2.00 * Average Footcandles at 2.5' Above Floor ** Exceeds Spacing Ratio by 11% *** Exceeds Spacing Ratio by 10%					
	55° 29	Total 2020 100%	14' 29 fc 7.1' 13 fc						
	90° 2		16' 22 fc 8.1' 10 fc						
			20' 14 fc 10.2' 7 fc						
			24' 10 fc 12.2' 5 fc						
		28' 7 fc 14.2' 3 fc							

Delivered Lumens: 2020
Luminaire Watts: 20.4
LER: 99.02

CP at 0° (Nadir): 5723
CRI: 80

Beam Angle: 28°
Spacing Ratio: 0.47

Lumen Multiplier: N/A. 30L only
CCT Multiplier: 27K x 0.96, 30K x 0.98, 40K x 1.04
27HK x 0.87, 30HK x 0.81

IF03RMx xx PC 835 030 DLFLGP MW - Shallow

CANDLEPOWER CURVE TEST SP-00758_2_M-30L	INTENSITY CANDELA 0° AZIMUTH	ZONAL LUMENS	SINGLE UNIT: PERFORMANCE DIRECT FOOTCANDLES BASED ON DOWNLIGHT ONLY	MULTIPLE UNITS: PERFORMANCE 80/50/20% REFLECTANCES INITIAL FOOTCANDLES AND WATTS PER SQUARE FOOT					
	0°	0° - 10° 353 18%	Mounting Height AFF	Ceiling Height	Fixture Spacing	RCR 3		RCR 5	
	0° 4047	0° - 20° 1067 53%	FC at Center on Floor	FC *	W/Sq. Ft.	FC *	W/Sq. Ft.	FC *	W/Sq. Ft.
	5° 3826	0° - 30° 1652 82%	Beam Diameter	14'	6'	48	0.50	53	0.62
	15° 2584	0° - 40° 1901 94%	FC at Beam Edge	18'	8'	26	0.28	29	0.34
	25° 1278	0° - 60° 1981 98%	8' 63 fc 5.5' 27 fc	22'	10'	17	0.17	18	0.21
	35° 392	0° - 80° 2009 100%	10' 40 fc 6.9' 17 fc	Delivered Illuminance Rating: (DIR)		95 FC per W/Sq. Ft.		85 FC per W/Sq. Ft.	
	45° 57	0° - 90° 2012 100%	12' 28 fc 8.3' 12 fc	Recessed mounting Square rooms used for multiple units: RCR 3: Length & Width = Ceiling Ht. - 2.5' x 3.33 RCR 5: Length & Width = Ceiling Ht. - 2.5' x 2.00 * Average Footcandles at 2.5' Above Floor					
	55° 24	Total 2012 100%	14' 21 fc 9.7' 9 fc						
	90° 2		16' 16 fc 11.0' 7 fc						
			20' 10 fc 13.8' 4 fc						
			24' 7 fc 16.6' 3 fc						
		28' 5 fc 19.3' 2 fc							

Delivered Lumens: 2012
Luminaire Watts: 20.4
LER: 98.63

CP at 0° (Nadir): 4047
CRI: 80

Beam Angle: 38°
Spacing Ratio: 0.60

Lumen Multiplier: N/A. 30L only
CCT Multiplier: 27K x 0.96, 30K x 0.98, 40K x 1.04
27HK x 0.87, 30HK x 0.81

IF03RMx xx PC 835 030 DLWFGP MW - Shallow

CANDLEPOWER CURVE TEST SP-00761_2_M-30L	INTENSITY CANDELA 0° AZIMUTH	ZONAL LUMENS		SINGLE UNIT: PERFORMANCE DIRECT FOOTCANDLES BASED ON DOWNLIGHT ONLY				MULTIPLE UNITS: PERFORMANCE 80/50/20% REFLECTANCES INITIAL FOOTCANDLES AND WATTS PER SQUARE FOOT							
		0° - 10°	172	9%	Mounting Height AFF	FC at Center on Floor	Beam Diameter	FC at Beam Edge	Ceiling Height	Fixture Spacing	RCR 2		RCR 4		
	0°	1827	0° - 20°	627	34%	8'	29 fc	9.4'	9 fc	10'	6'	47	0.52	40	0.52
	5°	1800	0° - 30°	1199	65%	10'	18 fc	11.8'	6 fc	14'	8'	27	0.30	17	0.22
	15°	1614	0° - 40°	1566	85%	12'	13 fc	14.1'	4 fc	18'	10'	19	0.22	17	0.22
	25°	1287	0° - 60°	1801	98%	14'	9 fc	16.5'	3 fc	Delivered Illuminance Rating: (DIR)		90 FC per W/Sq. Ft.		77 FC per W/Sq. Ft.	
	35°	563	0° - 80°	1840	100%	16'	7 fc	18.9'	2 fc	Recessed mounting Square rooms used for multiple units: RCR 2: Length & Width = Ceiling Ht. - 2.5' x 5.00 RCR 4: Length & Width = Ceiling Ht. - 2.5' x 2.50 * Average Footcandles at 2.5' Above Floor					
	45°	192	0° - 90°	1842	100%	20'	5 fc	23.6'	1 fc						
	55°	84	Total	1842	100%	24'	3 fc	28.3'	1 fc						
	90°	1				28'	2 fc	33.0'	1 fc						

Delivered Lumens: 1842
Luminaire Watts: 20.4
LER: 90.29

CP at 0° (Nadir): 1827
CRI: 80

Beam Angle: 61°
Spacing Ratio: 0.95

Lumen Multiplier: N/A. 30L only
CCT Multiplier: 27K x 0.96, 30K x 0.98, 40K x 1.04
27HK x 0.87, 30HK x 0.81

IF03RMx xx PC 835 030 WW WF LW MW - Wall Wash, Shallow

CANDLEPOWER CURVE TEST SP-00849_M-30L	PERFORMANCE SUMMARY	REFERENCE DIAGRAM
--	---------------------	-------------------

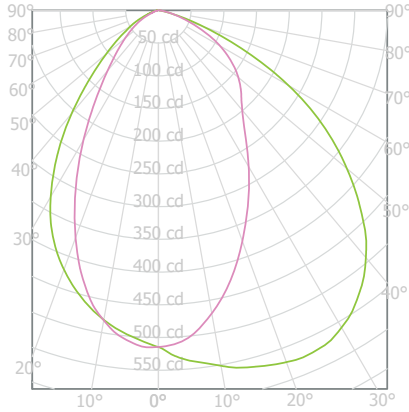

Delivered Lumens: 898
 Luminaire Watts: 20.4
 LER: 44.02
 CP at 0deg (Nadir): 514
 CRI: 80
 Lumen Multiplier: N/A. 30L only
 CCT Multiplier: 27K x 0.96, 30K x 0.98, 40K x 1.04
 27HK x 0.87, 30HK x 0.81

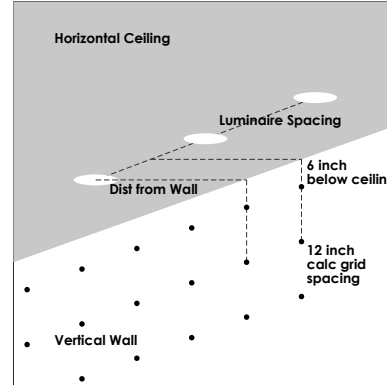

PERFORMANCE DATA - INITIAL ILLUMINATION (FOOTCANDLES) ON WALL - DIRECT LIGHT ONLY

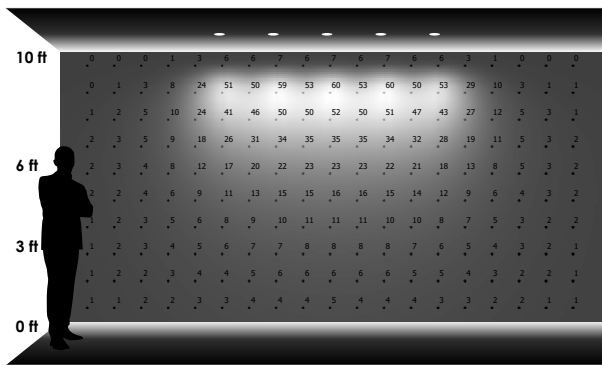

5 LUMINAIRES
 2' away from wall
 2' between luminaires

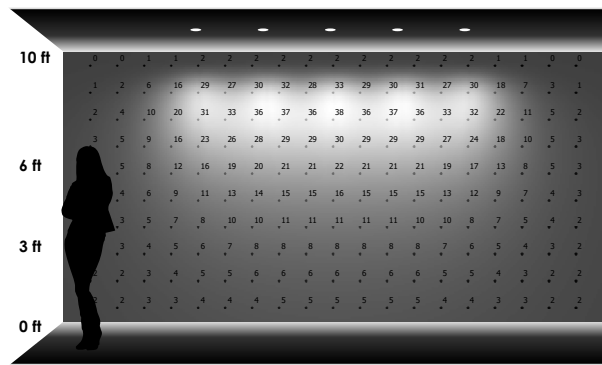

5 LUMINAIRES
 2'-6" away from wall
 2'-6" between luminaires

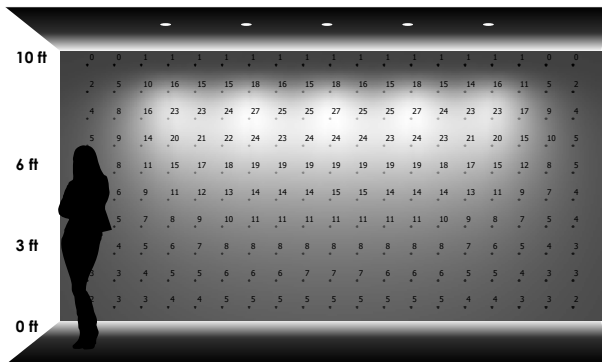

5 LUMINAIRES
 3' away from wall
 3' between luminaires

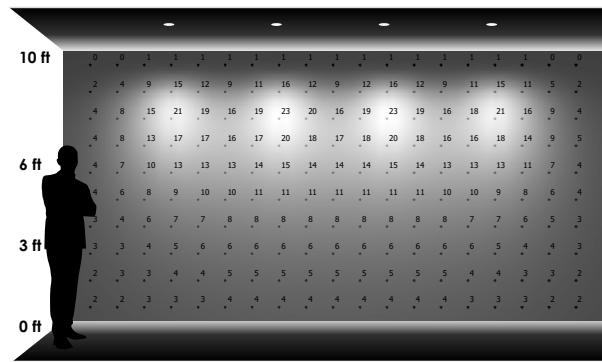

4 LUMINAIRES
 3' away from wall
 4' between luminaires

IF03RSx IC 835 015 N11 DLSPGP MW - Super Shallow

CANDLEPOWER CURVE TEST SP-00776_2_M-015L	INTENSITY CANDELA 0° AZIMUTH	ZONAL LUMENS	SINGLE UNIT: PERFORMANCE INITIAL FOOTCANDLES BASED ON IES BEAM ANGLE				MULTIPLE UNITS: PERFORMANCE 80/50/20% REFLECTANCES INITIAL FOOTCANDLES AND WATTS PER SQUARE FOOT								
			Mounting Height AFF	FC at Center on Floor	Beam Diameter	FC at Beam Edge	Ceiling Height	Fixture Spacing	RCR 3		RCR 5				
	0.00°		0° - 10°	278	26%	5.5'	122 fc	2.3'	61 fc	9'	2'	272	2.63	203	2.17
	0.00°	3,692	0° - 20°	649	61%	6.5'	87 fc	2.7'	44 fc	12'	4'	67	0.65	66	0.71
	5.00°	3,272	0° - 30°	893	84%	7.5'	66 fc	3.2'	33 fc	16'	6'	33	0.32	33	0.35
	10.00°	2,254	0° - 40°	1,003	94%	8.5'	51 fc	3.6'	26 fc	Delivered Illuminance Rating: (DIR)		103 FC per W/Sq. Ft.		93 FC per W/Sq. Ft.	
	15.00°	1,331	0° - 60°	1,045	98%	10.0'	37 fc	4.2'	18 fc	Recessed Mounting Square rooms used for multiple units: - RCR 3: Length & Width = Ceiling Ht. -2.5' x 3.33 - RCR 5: Length & Width = Ceiling Ht. -2.5' x 2.00 + Average Footcandles at 2.5' Above Floor					
	20.00°	795	0° - 80°	1,063	100%	12.0'	26 fc	5.1'	13 fc						
	30.00°	335	0° - 90°	1,064	100%	14.0'	19 fc	5.9'	9 fc						
	40.00°	63	Total	1,064	100%	16.0'	14 fc	6.8'	7 fc						
	50.00°	21													
	60.00°	16													
	70.00°	8													
	80.00°	3													
90.00°	1														

Delivered Lumens: 1,064
Luminaire Watts: 10.2
LER: 104.31

CP at 0deg (Nadir): 3,692
CRI: 80

Beam Angle: 24
Spacing Ratio: 0.4

Lumen Multiplier: 07L x 0.40, 10L x 0.56
CCT Multiplier: 27K x 0.95, 30K x 0.98, 40K x 1.03

IF03RSx IC 835 015 DLNFGP MW - Super Shallow

CANDLEPOWER CURVE TEST SP-00775_2_M-015L	INTENSITY CANDELA 0° AZIMUTH	ZONAL LUMENS	SINGLE UNIT: PERFORMANCE INITIAL FOOTCANDLES BASED ON IES BEAM ANGLE				MULTIPLE UNITS: PERFORMANCE 80/50/20% REFLECTANCES INITIAL FOOTCANDLES AND WATTS PER SQUARE FOOT								
			Mounting Height AFF	FC at Center on Floor	Beam Diameter	FC at Beam Edge	Ceiling Height	Fixture Spacing	RCR 3		RCR 5				
	0.00°	2,976	0° - 10°	245	23%	5.5'	98 fc	2.8'	49 fc	9'	2'	267	2.63	199	2.17
	5.00°	2,804	0° - 20°	625	59%	6.5'	70 fc	3.3'	35 fc	12'	4'	66	0.65	65	0.71
	10.00°	2,164	0° - 30°	876	83%	7.5'	53 fc	3.8'	26 fc	16'	6'	25	0.25	21	0.22
	15.00°	1,345	0° - 40°	992	94%	8.5'	41 fc	4.3'	21 fc	Delivered Illuminance Rating: (DIR)		102 FC per W/Sq. Ft.		92 FC per W/Sq. Ft.	
	20.00°	778	0° - 60°	1,033	98%	10.0'	30 fc	5.1'	15 fc	Recessed Mounting Square rooms used for multiple units: - RCR 3: Length & Width = Ceiling Ht. -2.5' x 3.33 - RCR 5: Length & Width = Ceiling Ht. -2.5' x 2.00 + Average Footcandles at 2.5' Above Floor					
	30.00°	326	0° - 80°	1,049	100%	12.0'	21 fc	6.1'	10 fc						
	40.00°	53	0° - 90°	1,051	100%	14.0'	15 fc	7.1'	8 fc						
	50.00°	20	Total	1,051	100%	16.0'	12 fc	8.1'	6 fc						
	60.00°	13													
	70.00°	7													
	80.00°	3													
	90.00°	1													

Delivered Lumens: 1,051
Luminaire Watts: 10.2
LER: 103.04

CP at 0deg (Nadir): 2,976
CRI: 80

Beam Angle: 28.27
Spacing Ratio: 0.47

Lumen Multiplier: 07L x 0.40, 10L x 0.56
CCT Multiplier: 27K x 0.95, 30K x 0.98, 40K x 1.03

IF03RSx IC 835 015 N11 DLFLGP MW - Super Shallow

CANDLEPOWER CURVE TEST SP-00774_2_M-015L	INTENSITY CANDELA 0° AZIMUTH	ZONAL LUMENS	SINGLE UNIT: PERFORMANCE INITIAL FOOTCANDLES BASED ON IES BEAM ANGLE				MULTIPLE UNITS: PERFORMANCE 80/50/20% REFLECTANCES INITIAL FOOTCANDLES AND WATTS PER SQUARE FOOT								
			Mounting Height AFF	FC at Center on Floor	Beam Diameter	FC at Beam Edge	Ceiling Height	Fixture Spacing	RCR 3		RCR 5				
	0.00°	2,104	0° - 10°	184	18%	5.5'	70 fc	3.8'	35 fc	9'	4'	55	0.54	49	0.54
	5.00°	1,989	0° - 20°	555	53%	6.5'	50 fc	4.5'	25 fc	12'	4'	65	0.65	63	0.71
	10.00°	1,705	0° - 30°	859	82%	7.5'	37 fc	5.2'	19 fc	16'	6'	25	0.25	20	0.22
	15.00°	1,344	0° - 40°	989	94%	8.5'	29 fc	5.9'	15 fc	Delivered Illuminance Rating: (DIR)		100 FC per W/Sq. Ft.		90 FC per W/Sq. Ft.	
	20.00°	975	0° - 60°	1,030	98%	10.0'	21 fc	6.9'	11 fc	Recessed Mounting Square rooms used for multiple units: - RCR 3: Length & Width = Ceiling Ht. -2.5' x 3.33 - RCR 5: Length & Width = Ceiling Ht. -2.5' x 2.00 + Average Footcandles at 2.5' Above Floor					
	30.00°	422	0° - 80°	1,045	100%	12.0'	15 fc	8.3'	7 fc						
	40.00°	72	0° - 90°	1,046	100%	14.0'	11 fc	9.7'	5 fc						
	50.00°	17	Total	1,046	100%	16.0'	8 fc	11.0'	4 fc						
	60.00°	10													
	70.00°	7													
	80.00°	3													
	90.00°	1													

Delivered Lumens: 1,046
Luminaire Watts: 10.2
LER: 102.55

CP at 0deg (Nadir): 2,104
CRI: 80

Beam Angle: 38
Spacing Ratio: 0.6

Lumen Multiplier: 07L x 0.40, 10L x 0.56
CCT Multiplier: 27K x 0.95, 30K x 0.98, 40K x 1.03

IF03RSx xx PC 835 015 WW WF LW MW - Wall Wash, Super Shallow

CANDLEPOWER CURVE
TEST SP-00897_M-015L

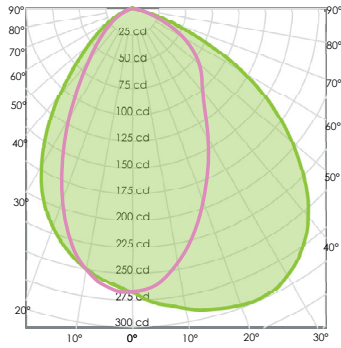

PERFORMANCE SUMMARY

Delivered Lumens: 467
 Luminaire Watts: 10.2
 LER: 45.78
 CP at 0deg (Nadir): 268
 CRI: 80+
 Lumen Multiplier: 07L x 0.4, 10L x 0.56
 CCT Multiplier: 27K x 0.95, 30K x 0.98, 40K x 1.03

REFERENCE DIAGRAM

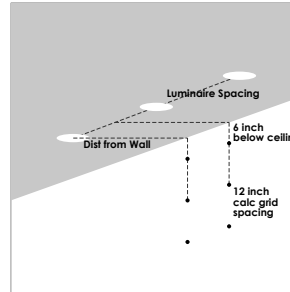

PERFORMANCE DATA - INITIAL ILLUMINATION (FOOTCANDLES) ON WALL - DIRECT LIGHT ONLY

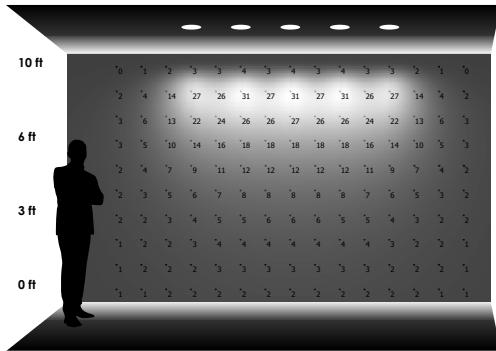

5 LUMINAIRES
2' away from wall
2' between luminaires

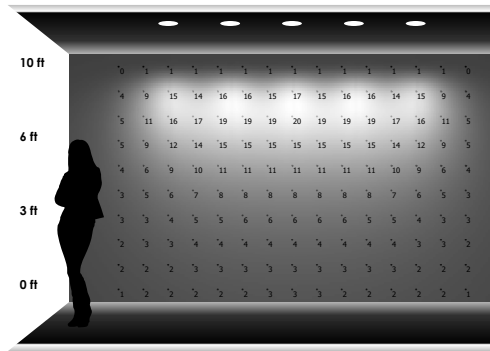

5 LUMINAIRES
2'-6" away from wall
2'-6" between luminaires



5 LUMINAIRES
3' away from wall
3' between luminaires

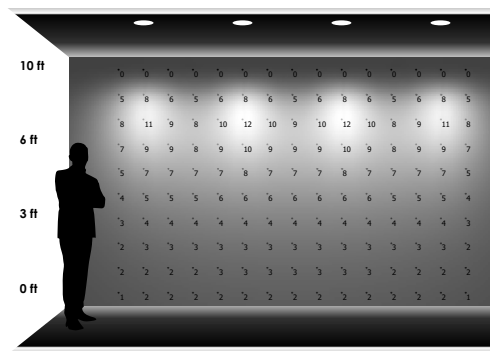

4 LUMINAIRES
3' away from wall
4' between luminaires