



EMBLEM SIGN
DAMP / WET LOCATION
SIGN LIGHTS

PROJECT: _____
 QUANTITY: _____ TYPE: _____



EB1214GV
 MB - Matte Black



EB1214GV
 AZ - Anodic Bronze



EB1214GV
 PT - Platinum Silver



EB1214GV
 RD - Red Baron

SERIES	LUMENS ¹	CCT	DRIVER / DIMMING ²	ACCESSORIES ⁴	MOUNTING ⁷	FINISH ¹¹	WET KIT	
EB0709GV EB0910GV EB1214GV	15L 1500 Lm 27L 2700 Lm	80 CRI 27K 2700K 30K 3000K 35K 3500K 40K 4000K 90 CRI 27HK 2700K 30HK 3000K 35HK 3500K 40HK 4000K	EX DO10X DS2W1 DLTE1 ³ DL3EX ³	Electronic Driver, 120V/277V 1%, 0-10V, 120V/277V ELV/MLV, 120V Lutron® 2-Wire Forward Phase (MLV), 120V 1%, Lutron® EcoSystem®, Fades to Black, 120V/277V	ENCLOSURES TF1 ⁶ 3" Frosted Dome TG1 ⁶ 3" Dome Wire Guard MF1 3" Frosted Mini MG1 3" Short Wire Guard FJ1 3" Frosted Tall FG1 3" Tall Wire Guard	WALL MOUNT CP104 Small Driver Canopy CP104KO Small Driver Canopy w/ Knockouts CP106 Large Driver Canopy CP6/RMD Remote Mount Driver SP90 ⁸ Straight Arm PA ⁸ Mounting Arm Style CEILING MOUNT RDC5 Small Driver Canopy CP13 Large Driver Canopy HM ⁹ Hang Straight AT ⁹ Hang Straight All Thread PM ⁹ Rigid Pendant Mount EMCR ¹⁰ 10W Large Driver Canopy EM EMRM 7W Remote EM EMEN 7W Remote with Enclosure	MW ¹² Matte White MB ¹² Matte Black PT ¹² Platinum Silver CC Custom Color	WLKA Wet Location Kit

EXAMPLE: EB1214GV15L35KEXTF1/CP104PA36BL

NOTES:
 1 Nominal Source Lumens at 35K 2 Contact Factory for Additional Options 3 Available with CP106/CP13 Only 4 Enclosure, Wire Guard Required - Choose One Option
 5 Standard Enclosure 6 TG1 Not Available With EB0709 7 See Mounting Page for Details on Components and Finishes 8 See Mounting Page for Available Arm Options
 9 Specify Length in Inches: See Mounting Page for Available Lengths 10 EMCR Replaces RDC5 or CP13 11 Reference Color Sheet Located on Product Webpage for Full List of Available Colors 12 Standard Finishes





EMBLEM SIGN DAMP / WET LOCATION SIGN LIGHTS

LUMENS / WATTAGE DATA				
PART NUMBER	SOURCE LUMENS ¹	DELIVERED LUMENS ²	SYSTEM WATTS	LPW
EB1214GV15L	1500	1251	10	125
EB1214GV27L	2700	2184	18	121

¹ Nominal Source Lumens at 35K ² Nominal Delivered Lumens at 35K

HOUSING DIMENSIONS

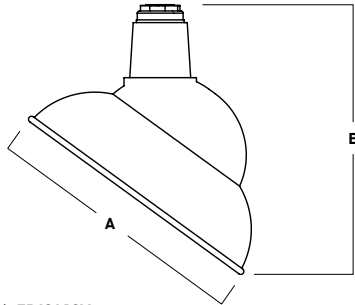

Dimensioned with **EB1214GV**

SERIES	A	B
EB0709GV	7.1	9.7
EB0910GV	8.8	9.8
EB1214GV	12.4	12.1

APPLICATION

Emblem Sign light is perfect for a variety of sign and surface lighting applications.

FEATURES

Spectrum Lighting's RLM Classics are inspired by vintage lighting fixtures redesigned with modern LED light sources and materials. The wide range of options for illumination, mounting, enclosures, guards and finishes allows for creative fixture specification and design. LED module and driver are serviceable for future replacement. Available in three sizes.

FINISH

Multi-stage polyester powder-coat process applied on our dedicated paint lines. Variety of standard and custom finishes are available. Matte White interior standard.

ELECTRONICS

GV LED system features high brightness white Samsung LED's. 3-step MacAdam Ellipse binning. Standard CRI: 80+. Higher CRI, R9 and custom LED configurations are available; consult factory. Choice of electronic 120V/277V and dimming drivers.

CONSTRUCTION

Fixture shades are spun in our factory from 0.063 high purity aluminum. Wall mount canopies are die-cast aluminum with stainless steel hardware. Wall arms are formed 3/4 NPT aluminum pipe and may be field cut.

CODE COMPLIANCE

BAA compliant. ETL certified to meet US and Canadian standards. Suitable for dry or damp locations. Wet Location Option. Manufactured and tested to UL standards No. 1598/8750.

SERIES SIZES

EB0709GV



EB0910GV



EB1214GV



ENCLOSURES

TF1
3" FROSTED DOME



MF1
3" FROSTED MINI



FJ1
3" FROSTED TALL



TC1
3" FROSTED DOME
WIRE GUARD - FITS TF1



MG1
3" FROSTED MINI
WIRE GUARD - FITS MF1



FG1
3" FROSTED TALL
WIRE GUARD - FITS FJ1



WALL MOUNT

(SEE MOUNTING PAGES FOR MORE OPTIONS & DIMENSIONS.)

PA_
MOUNTING ARM STYLE



EB1214GV SHOWN WITH CPT04PA23

CEILING MOUNT

(SEE MOUNTING PAGES FOR MORE OPTIONS & CANOPY DIMENSIONS.)

HM / AT / PM
HANG STRAIGHT / ALL THREAD / PENDANT



EB1214GV SHOWN WITH RDC5PM





EMBLEM SIGN
DAMP / WET LOCATION
SIGN LIGHTS / PHOTOMETRIC DATA

EB1214GV-27L-35K-EX-TF1-MWI

CANDLEPOWER CURVE	INTENSITY	ZONAL LUMENS	SINGLE UNIT: PERFORMANCE INITIAL FOOTCANDLES BASED ON IES BEAM ANGLE				MULTIPLE UNITS: PERFORMANCE 80/50/20% REFLECTANCES INITIAL FOOTCANDLES AND WATTS PER SQUARE FOOT											
			Mounting Height AFF	FC at Center on Floor	Beam Diameter	FC at Beam Edge	Ceiling Height	Fixture Spacing	RCR 2		RCR 4							
	0.00°																	
	0.00° 920	0° - 10°	89	4%	5.50'	30 fc	9.8'	10 fc	8'	8'	25	0.24	20	0.24				
	5.00° 919	0° - 20°	336	15%	6.50'	22 fc	11.6'	7 fc	12'	10'	22	0.20	17	0.20				
	10.00° 917	0° - 30°	649	30%	7.50'	16 fc	13.4'	5 fc	16'	12'	14	0.14	7	0.09				
	15.00° 908	0° - 40°	977	45%	8.50'	13 fc	15.2'	4 fc	Delivered Illuminance Rating: (DIR)									
	20.00° 891	0° - 60°	1,589	73%	10.00'	9 fc	17.9'	3 fc	106 FC per W/Sq. Ft. 84 FC per W/Sq. Ft.									
	30.00° 840	0° - 80°	1,928	88%	12.00'	6 fc	21.4'	2 fc	2' Suspension Length									
	40.00° 761	0° - 90°	2,018	92%	14.00'	5 fc	25.0'	1 fc	Square rooms used for multiple units:									
	50.00° 651	Total	2,183	100%	16.00'	4 fc	28.6'	1 fc	- RCR 2: Length & Width = Ceiling Ht. - 4.5' x 5.00'									
	60.00° 273								- RCR 4: Length & Width = Ceiling Ht. - 4.5' x 2.50'									
	70.00° 66								* Average Footcandles at 2.5' Above Floor									
	80.00° 42								** Exceeds spacing criteria by 69%									
90.00° 19								*** Exceeds spacing criteria by -23%										
Delivered Lumens: 2,183	CP at 0deg (Nadir): 920	Beam Angle: 93.07	Lamp Multiplier: 15L x 0.573															
Luminaire Watts: 18	CRI: 85+	Spacing Ratio: 1.35	CCT Multiplier: 27K x 0.971, 30K x 0.985, 40K x 1.03															
LER: 121.28																		



MOUNTING & ACCESSORIES

SOME OPTIONS NOT AVAILABLE ON ALL FIXTURES. CONSULT SPECIFICATION SHEETS. SEE INDIVIDUAL SPECIFICATION SHEETS OR CONSULT FACTORY FOR ADDITIONAL INFORMATION. NOTE: THIS IS TYPICAL OF RLM SPECIFICATION FOR MOUNTING. INDIVIDUAL FIXTURES OR PROJECTS MAY HAVE SPECIALIZED REQUIREMENTS.



WALL MOUNTING

CP104 - SMALL DRIVER CANOPY (STANDARD)
MAY BE USED AS SPLICE BOX FOR DIRECT FEED
NOT AVAILABLE W/ PA16 & PA16F

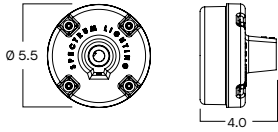

CP106 - LARGE DRIVER CANOPY
MAY BE USED AS SPLICE BOX FOR DIRECT FEED

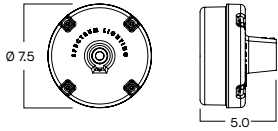

CP6/RMD - REMOTE MOUNT DRIVER
MOUNTS DIRECTLY TO WALL OR OCTAGON STYLE J-BOX

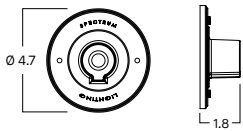

CUSTOM AND OTHER WALL ARMS AVAILABLE - CONTACT FACTORY. ARMS MAY BE FIELD CUT ON WALL SIDE - FIXTURE SIDE THREADED 3/4" NPT REQUIRES SEALANT FOR WET LOCATION.

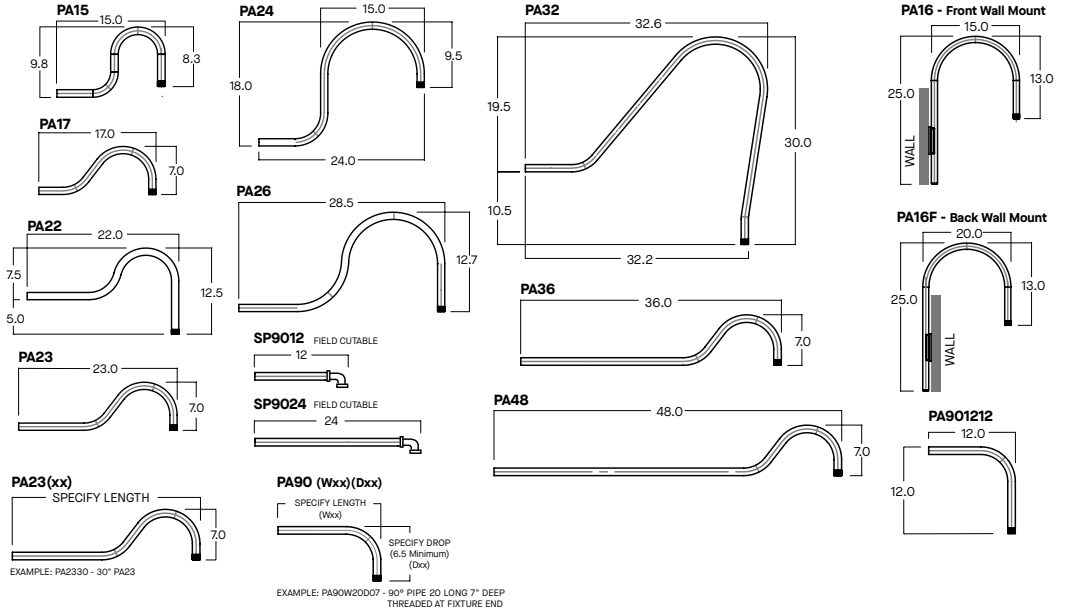

CEILING MOUNTING

RDC5 - SMALL DRIVER CANOPY (STANDARD)
MOUNTS TO 4" OCTO J-BOX

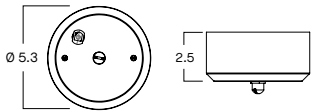

CP13 - LARGE DRIVER CANOPY

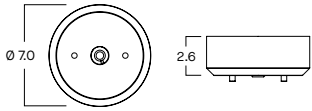

HM*
HANG STRAIGHT
45° SWIVEL 5/8" OD STEM - 3/8" IP

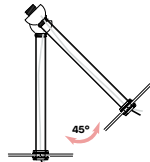

ORDER: HM (Length)
SPECIFY LENGTH:
HM3 - 3" HM24 - 24"
HM6 - 6" HM36 - 36"
HM12 - 12" HM48 - 48"
HM18 - 18" HM72 - 72"
HMLC(XX)
Custom Length
(Specify in Inches)

PM*
RIDGID PENDANT MOUNT
RIGID 5/8" OD STEM - 3/8" IP



ORDER: PM (Length)
SPECIFY LENGTH:
PM3 - 3" PM24 - 24"
PM6 - 6" PM36 - 36"
PM12 - 12" PM48 - 48"
PM18 - 18" PM72 - 72"
PMLC(XX)
Custom Length
(Specify in Inches)

AT**
HANG STRAIGHT ALL THREAD
45° SWIVEL 5/8" OD STEM - 1/4" IP

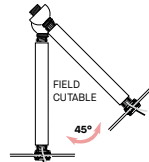

ORDER: AT (Length)
SPECIFY LENGTH:
AT12 - 12"
AT24 - 24"
AT36 - 36"
AT48 - 48"
AT60 - 60"
AT72 - 72"
FIELD CUT THREADED PIPE TO LENGTH NEEDED CUT PIPE COVER - 1/4" SHORTER THAN THREADED PIPE SLIP PIPE COVER OVER THREADED PIPE

*MAXIMUM ONE PIECE STEM LENGTH IS 72". **MAXIMUM ONE PIECE STEM LENGTH IS 36". LONGER LENGTHS ARE POSSIBLE USING MULTIPLE STEMS AND COUPLERS.
**ORDER IN 12" INCREMENTS, ODD SIZES MAY BE FIELD CUT

EMERGENCY BATTERY OPTIONS

EMCR - LARGE DRIVER CANOPY FOR 10W EMERGENCY BATTERY

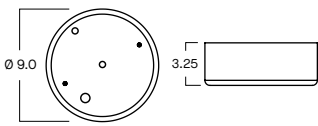

REMOTE EMERGENCY BATTERY OPTIONS

EMRM* - 7W REMOTE EMERGENCY BATTERY (50' MAX)

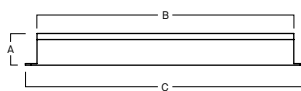

A	B	C
1.3	12.6	13.0

EMEN* - 7W REMOTE EMERGENCY BATTERY WITH ENCLOSURE (50' MAX)

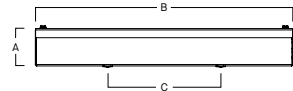

A	B	C
2.0	17.0	6.2

*OTHER EM BATTERY SIZES AVAILABLE, CONTACT FACTORY.

