



**WAREHOUSE DOME**  
**DAMP / WET LOCATION**  
 CLASSIC SHAPES

PROJECT: \_\_\_\_\_  
 QUANTITY: \_\_\_\_\_ TYPE: \_\_\_\_\_



WD1812GV  
EG - Evergreen



WD1812GV  
OR - Orange



WD1812GV  
GW - Gloss White



WD1812GV  
TQ - Turquoise

SERIES	LUMENS <sup>1</sup>	CCT	DRIVER / DIMMING <sup>2</sup>	ACCESSORIES <sup>3</sup>	MOUNTING <sup>5</sup>	INTERIOR <sup>3</sup>	FINISH <sup>6</sup>	WET KIT
<b>WD1611GV</b> <b>WD1812GV</b> <b>WD2015GV</b>	<b>15L</b> 1500 Lm <b>27L</b> 2700 Lm <b>37L</b> 3700 Lm <b>55L</b> 5500 Lm	80 CRI <b>27K</b> 2700K <b>30K</b> 3000K <b>35K</b> 3500K <b>40K</b> 4000K 90 CRI <b>27HK</b> 2700K <b>30HK</b> 3000K <b>35HK</b> 3500K <b>40HK</b> 4000K	<b>EX</b> Electronic Driver, 120V/277V <b>DO10X DS2W1</b> 1%, 0-10V, 120V/277V ELV/MLV, 120V	<b>TF2<sup>2</sup></b> 4" Frosted Dome <b>TG2</b> 4" Dome Wire Guard <b>MF2</b> 4" Frosted Mini <b>MG2</b> 4" Short Wire Guard <b>FJ2</b> 4" Frosted Tall <b>FG2</b> 4" Tall Wire Guard	<b>WALL MOUNT</b> <b>CP6</b> Wall Mount Cover <b>SP90<sup>6</sup></b> Straight Arm <b>PA<sup>6</sup></b> Mounting Arm Style <b>CEILING MOUNT</b> <b>HM<sup>7</sup></b> Hang Straight <b>AT<sup>7</sup></b> Hang Straight All Thread <b>PM<sup>7</sup></b> Rigid Pendant Mount <b>CD<sup>7</sup></b> Cord / Cable Mount <b>CM<sup>7</sup></b> Cord Mount <b>EMCR</b> 10W Large Driver Canopy EM <b>EMRM</b> 7W Remote EM <b>EMEN</b> 7W Remote with Enclosure	<b>MW<sup>1</sup></b> Matte White <b>CC<sup>1</sup></b> Custom Color <b>FC<sup>1</sup></b> Fixture Color Interior See Page 5 for Full Range of Color Options (83-90082)	<b>MW<sup>2</sup></b> Matte White <b>MB<sup>2</sup></b> Matte Black <b>PT<sup>2</sup></b> Platinum Silver <b>CC<sup>2</sup></b> Custom Color See Page 5 for Full Range of Color Options (83-90082)	<b>WLKA</b> Wet Location Kit

EXAMPLE: WD1812GV15L30KEXTF2/HM36MWICH

**NOTES:**  
 1 Nominal Source Lumens at 35K 2 Contact Factory for Additional Options 3 Enclosure, Wire Guard Required - Choose One Option 4 Standard Enclosure  
 5 See Mounting Page for Details on Components and Finishes 6 See Mounting Page for Available Arm Options 7 Specify Length in Inches: See Mounting Page for Available Lengths  
 8 See Color Page for More Options/Consult Factory for Special Finishes 9 Standard Finishes





**WAREHOUSE DOME**  
**DAMP / WET LOCATION**  
 CLASSIC SHAPES

LUMENS / WATTAGE DATA				
PART NUMBER	SOURCE LUMENS <sup>1</sup>	DELIVERED LUMENS <sup>2</sup>	SYSTEM WATTS	LPW
WD1611GV15L	1500	1091	10	109
WD1611GV27L	2700	1906	18	106
WD1611GV37L	3700	2800	26	108
WD1611GV55L	5500	4117	39	106

<sup>1</sup> Nominal Source Lumens at 35K    <sup>2</sup> Nominal Delivered Lumens at 35K

**HOUSING DIMENSIONS**

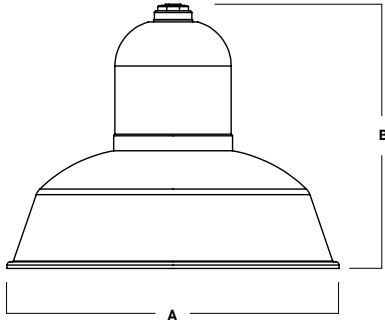

Dimensioned with **WD1812GV**

SERIES	A	B
WD1611GV	16.5	14.1
WD1812GV	18.5	14.7
WD2015GV	20.0	14.9

**APPLICATION**

The Warehouse Dome is designed for decorative general illumination.

**FEATURES**

Spectrum Lighting's RLM Classics are inspired by vintage lighting fixtures redesigned with modern LED light sources and materials. The wide range of options for illumination, mounting, enclosures, guards and finishes allows for creative fixture specification and design. LED driver is integral to fixture, special driver canopy is required. LED module and driver are serviceable for future replacement. Available in three sizes.

**FINISH**

Multi-stage polyester powder-coat process applied on our dedicated paint lines. Variety of standard and custom finishes are available. Interior is Matte White unless specified. Custom Color interior finish available.

**ELECTRONICS**

GV LED system features high brightness white Samsung LED's. 3-step MacAdam Ellipse binning. Standard CRI: 80+. Higher CRI, R9 and custom LED configurations are available; consult factory. Choice of electronic 120V/277V and dimming drivers.

**CONSTRUCTION**

Fixture shades are spun in our factory from 0.063 high purity aluminum. Wall mount canopies are die-cast aluminum with stainless steel hardware. Wall arms are formed 3/4 NPT aluminum pipe and may be field cut.

**CODE COMPLIANCE**

BAA compliant. ETL certified to meet US and Canadian standards. Suitable for dry or damp locations. Wet Location Option. Manufactured and tested to UL standards No. 1598/8750.

**SERIES SIZES**

**WD1611GV**



**WD1812GV**



**WD2015GV**



**ENCLOSURES**

**TF2**  
4" FROSTED DOME



**MF2**  
4" FROSTED MINI



**FJ2**  
4" FROSTED TALL



**TG2**  
4" FROSTED DOME  
WIRE GUARD - FITS TF2



**MG2**  
4" FROSTED MINI  
WIRE GUARD - FITS MF2



**FG2**  
4" FROSTED TALL  
WIRE GUARD - FITS FJ2



**WALL MOUNT**

(SEE MOUNTING PAGES FOR MORE OPTIONS & DIMENSIONS.)

**PA**  
MOUNTING ARM STYLE



WD1812GV SHOWN WITH PA23

**CEILING MOUNT**

(SEE MOUNTING PAGES FOR MORE OPTIONS & CANOPY DIMENSIONS.)

**HM / AT / PM**  
HANG STRAIGHT / ALL THREAD / PENDANT



WD1812GV SHOWN WITH HM

**CD**  
CORD / CABLE MOUNT



WD1812GV SHOWN WITH CD

**CM**  
CORD MOUNT



WD1812GV SHOWN WITH CM



**WAREHOUSE DOME**  
**DAMP / WET LOCATION**  
 CLASSIC SHAPES / PHOTOMETRIC DATA

WD1611GV-55L-35K-EX-TF2-MWI

CANDLEPOWER CURVE	INTENSITY	ZONAL LUMENS		SINGLE UNIT: PERFORMANCE				MULTIPLE UNITS: PERFORMANCE																	
				INITIAL FOOTCANDLES				80/50/20% REFLECTANCES																	
												INITIAL FOOTCANDLES AND WATTS PER SQUARE FOOT													
												Mounting Height AFF	FC at Center on Floor	Beam Diameter	FC at Beam Edge	Ceiling Height	Fixture Spacing	RCR 2		RCR 4					
																	FC *	W/Sq. Ft.	FC *	W/Sq. Ft.					
<p>Delivered Lumens: <b>4,116</b>            Luminaire Watts: <b>39</b>            LER: <b>105.54</b></p>												0.00°	0° - 10°	176	4%	6.0'	51 fc	15.1'	19 fc	14'	12'	27	0.28	22	0.28
												0.00° 1,828	0° - 20°	669	16%	8.0'	29 fc	20.2'	11 fc	18'	14'	21	0.21	11	0.14
												5.00° 1,827	0° - 30°	1,401	34%	10.0'	18 fc	25.2'	7 fc	22'	16'	13	0.13	15	0.18
												10.00° 1,797	0° - 40°	2,269	55%	12.0'	13 fc	30.3'	5 fc	Delivered Illuminance Rating: (DIR) 99 FC per W/Sq. Ft. 80 FC per W/Sq. Ft.					
												15.00° 1,751	0° - 60°	3,770	92%	14.0'	9 fc	35.3'	3 fc	2' Suspension Length Square rooms used for multiple units: - RCR 2: Length & Width = Ceiling Ht. - 4.5' x 5.00 - RCR 4: Length & Width = Ceiling Ht. - 4.5' x 2.50 * Average Footcandles at 2.5' Above Floor * Exceeds spacing criteria by 4% ** Exceeds spacing criteria by -14% *** Exceeds spacing criteria by -24%					
												20.00° 1,681	0° - 80°	4,092	99%	16.0'	7 fc	40.4'	3 fc	Lamp Multiplier: 15L x 0.265, 27L x 0.463, 37L x 0.68 CCT Multiplier: 27K x 0.971, 30K x 0.985, 40K x 1.03					
												30.00° 1,489	0° - 90°	4,116	100%	20.0'	5 fc	50.5'	2 fc						
												40.00° 1,286	Total	4,116	100%	24.0'	3 fc	60.5'	1 fc						
												50.00° 1,005													
												60.00° 361													

CP at 0deg (Nadir): **1,828**  
 CRI: **85+**

Beam Angle: **103.18**  
 Spacing Ratio: **1.21**

Lamp Multiplier: 15L x 0.265, 27L x 0.463, 37L x 0.68  
 CCT Multiplier: 27K x 0.971, 30K x 0.985, 40K x 1.03



# MOUNTING & ACCESSORIES

SOME OPTIONS NOT AVAILABLE ON ALL FIXTURES, CONSULT SPECIFICATION SHEETS. SEE INDIVIDUAL SPECIFICATION SHEETS OR CONSULT FACTORY FOR ADDITIONAL INFORMATION. NOTE: THIS IS TYPICAL OF RLM SPECIFICATION FOR MOUNTING. INDIVIDUAL FIXTURES OR PROJECTS MAY HAVE SPECIALIZED REQUIREMENTS.



## WALL MOUNTING

**CP6 - SMALL DRIVER CANOPY (STANDARD)**  
MAY BE USED AS SPLICE BOX FOR DIRECT FEED  
NOT AVAILABLE W/ PA16 & PA16F

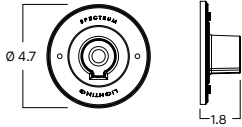

CUSTOM AND OTHER WALL ARMS AVAILABLE - CONTACT FACTORY. ARMS MAY BE FIELD CUT ON WALL SIDE - FIXTURE SIDE THREADED 3/4" NPT REQUIRES SEALANT FOR WET LOCATION.

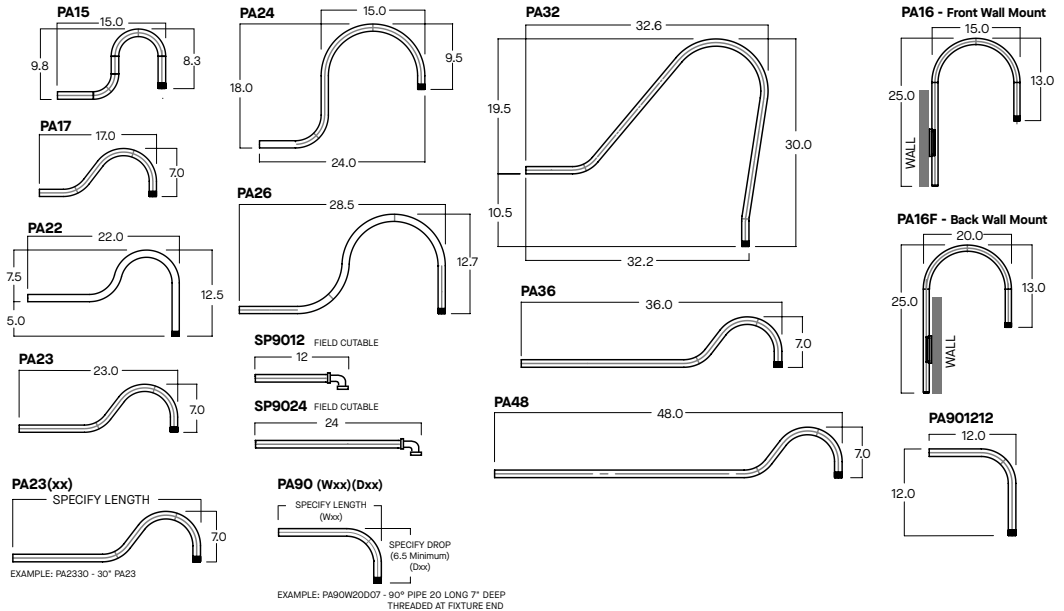

## CEILING MOUNTING

**HM\***  
HANG STRAIGHT  
45° SWIVEL 5/8" OD STEM - 3/8" IP

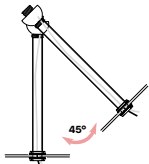

ORDER: HM (Length)  
SPECIFY LENGTH:  
HM3 - 3" HM24 - 24"  
HM6 - 6" HM36 - 36"  
HM12 - 12" HM48 - 48"  
HM18 - 18" HM72 - 72"  
HMLC(XX)  
Custom Length  
(Specify in Inches)

**PM\***  
RIGID PENDANT MOUNT  
RIGID 5/8" OD STEM - 3/8" IP

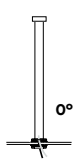

ORDER: PM (Length)  
SPECIFY LENGTH:  
PM3 - 3" PM24 - 24"  
PM6 - 6" PM36 - 36"  
PM12 - 12" PM48 - 48"  
PM18 - 18" PM72 - 72"  
PMLC(XX)  
Custom Length  
(Specify in Inches)

**AT\*\***  
HANG STRAIGHT ALL THREAD  
45° SWIVEL 5/8" OD STEM - 1/4" IP

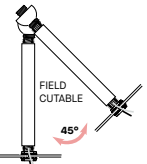

ORDER: AT (Length)  
SPECIFY LENGTH:  
AT12 - 12"  
AT24 - 24"  
AT36 - 36"  
AT48 - 48"  
AT60 - 60"  
AT72 - 72"  
FIELD CUT THREADED PIPE  
10' LENGTH MINIMUM  
CUT PIPE COVER 3/4" SHORTER  
THAN THREADED PIPE  
SLIP PIPE COVER OVER THREADED PIPE

**CD**  
CORD / CABLE MOUNT  
S/J CORD WITH 1/16 SS CABLE

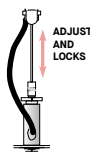

ORDER: CD (Length)  
SPECIFY LENGTH:  
CD36 - 36"  
CD72 - 72"  
CD144 - 144"  
CDLC(XX)  
Custom Length  
(Specify in Inches)

**CM**  
CORD MOUNT  
S/J CORD WITH STRAIN RELIEF



ORDER: CM (Length)  
SPECIFY LENGTH:  
CM36 - 36"  
CM72 - 72"  
CM144 - 144"  
CMLC(XX)  
Custom Length  
(Specify in Inches)

\*MAXIMUM ONE PIECE STEM LENGTH IS 72". \*\*MAXIMUM ONE PIECE STEM LENGTH IS 36". LONGER LENGTHS ARE POSSIBLE USING MULTIPLE STEMS AND COUPLERS. \*\*ORDER IN 12" INCREMENTS. ODD SIZES MAY BE FIELD CUT

## EMERGENCY BATTERY OPTIONS

**EMCR - LARGE DRIVER CANOPY FOR 10W EMERGENCY BATTERY**  
(FOR ROUND CEILING MOUNT TYPES)

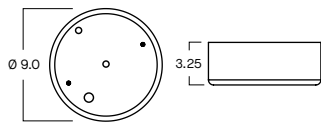

## REMOTE EMERGENCY BATTERY OPTIONS

**EMRM\* - 7W REMOTE EMERGENCY BATTERY**  
(50" MAX)

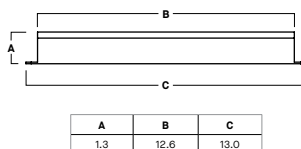

**EMEN\* - 7W REMOTE EMERGENCY BATTERY WITH ENCLOSURE**  
(50" MAX)

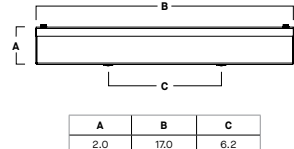

\*OTHER EM BATTERY SIZES AVAILABLE, CONTACT FACTORY.



# COLOR OPTIONS - POWDER COAT PAINT FINISHES

NOTE: NO PRINTED IMAGE CAN EQUAL THE EXACT COLOR OF FINISH ON METAL.  
SEE INDIVIDUAL SPECIFICATION SHEETS OR CONSULT FACTORY FOR ADDITIONAL INFORMATION.



## STANDARD CORD / STEM / CANOPY FINISHES

FIXTURE COLOR	STANDARD CORD COLOR	STANDARD CANOPY / STEM COLOR
Matte White, Textured White	Matte White	Matte White
Gloss White	Matte White	Gloss White
Matte Black, Gloss Black, Textured Black	Matte Black	Matte Black
All Others	Matte Black	Same Color as Fixture
Custom Color	Contact Factory	Contact Factory

## PAINT TIMES

TIER	COST	AVERAGE PAINT TIME*
Tier 1 - Standard Finishes	\$	⓪
Tier 2 - Typical Finishes	\$\$	⓪⓪
Tier 3 - Special Metal Finishes	\$\$\$	⓪⓪⓪
Custom Color	Contact Factory	Contact Factory

\*CONTACT FACTORY FOR SPECIFIC PRODUCT LEAD TIMES

## TIER 1 - STANDARD FINISHES

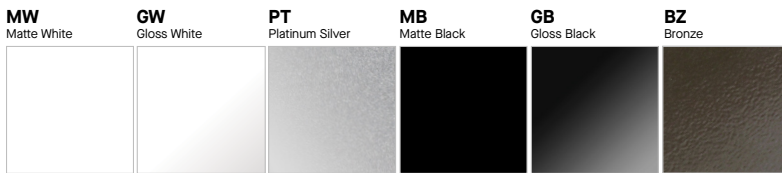

## TIER 2 - TYPICAL FINISHES

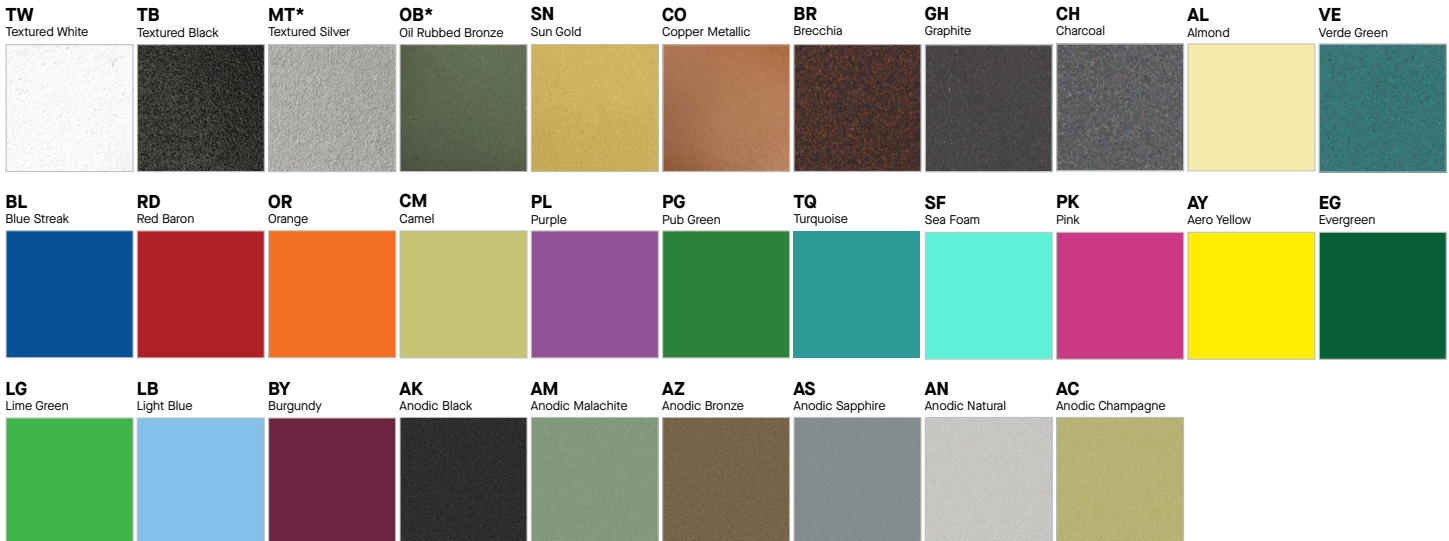

## TIER 3 - SPECIAL METAL FINISHES

NOT AVAILABLE ON ALL FIXTURES. PLEASE CONSULT SPECIFICATION SHEETS OR FACTORY FOR AVAILABILITY.

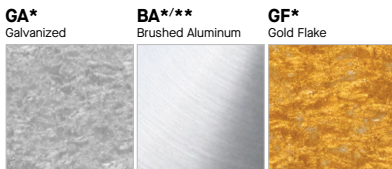

## CUSTOM COLOR FINISHES

CONTACT FACTORY

**CC**  
Custom Color



\*UNAVAILABLE FOR WET LOCATION

\*\* UNAVAILABLE FOR INTERIOR

