



# 16" Mid/High Bay 13800 Lm

Decorative Arms



## PRAF16LX

### APPLICATION

16" Arc Pendant evokes industrial age designs while using the latest LED technology for excellent general illumination. Prismatic refractor provides horizontal and vertical distribution. Laser cut decorative arm.

### FEATURES

Extruded Fixture Housing (EXT). Single-stage optical system for smooth light distribution. LED module and driver designed for ease of maintenance and replacement. Optional safety cable. Variety of mounting methods.

### FINISH

Multi-stage polyester powder-coat process applied on our dedicated paint lines. Variety of standard and custom finishes are available. All exposed materials are chromate pretreated to resist corrosion.

### ELECTRONICS

LED system features high brightness white Nichia LEDs. 3-step MacAdam Ellipse binning. Standard CRI: 80+. Higher CRI, R9 and custom LED configurations are available; consult factory. Variety of electronic 120V/277V and dimming drivers. LED module is 2 circuit with 2 drivers for multicircuit option.

### CONSTRUCTION

Extruded and machined 6063-T5 aluminum housing. Graphite gasket for optimal thermal management. Die-cast aluminum heat sink. Refractor made of cast UV stabilized acrylic. ARC pendant arms and deco ring are laser cut 5052 aluminum.

### CODE COMPLIANCE

BAA compliant. ETL certified to meet US and Canadian standards. Suitable for dry or damp locations. Manufactured and tested to UL standards No. 1598/8750.

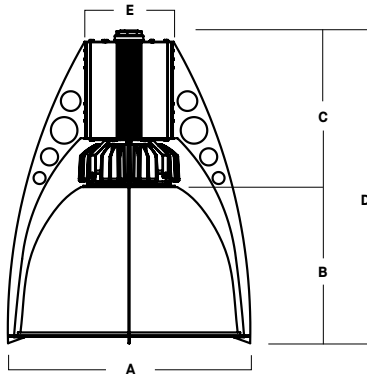

A	B	C	D	E
17.6	11.4	10.6	22.0	6.5
447.0 mm	289.6 mm	269.2 mm	558.8 mm	165.1 mm

LUMENS / WATTAGE DATA			
PART NUMBER	DELIVERED LUMENS <sup>1</sup>	SYSTEM WATTS	LPW
PRAF16LX65L	7386	52	142
PRAF16LX100L	10510	80	131
PRAF16LX130L	13204	98	135
PRAF16LX140L	13815	107	129

<sup>1</sup> Nominal Delivered Lumens at 35K with PR16AFPFMW

SERIES	LUMENS <sup>1</sup>	CCT	DRIVER / DIMMING <sup>2</sup>	SAFETY OPTIONS <sup>3</sup>	MOUNTING <sup>4</sup>	REFRACTOR	ENCLOSURE OPTION	TIER OPTIONS	OPTIONS	FINISH <sup>10</sup>	MOUNTING OPTION <sup>12</sup>
PRAF16LX	65L 7400 Lm 100L 10500 Lm 130L 13200 Lm 140L 13800 Lm	27K 2700K 30K 3000K 35K 3500K 40K 4000K	EX Electronic Driver, 120V/277V DS10X 10%, 0-10V, 120V/277V DO10X 1%, 10-0V, 120V/277V DO103 1%, 0-10V, 347V	FS Fusing 2CIR 2 Circuit SC1 Safety Cable	HM <sup>5</sup> Hang Straight PM <sup>5</sup> Rigid Pendant CD <sup>5</sup> Cord / Cable Mount HC <sup>5/6/7</sup> Hook & Cord NM2 <sup>8/7/8</sup> 1/2" NPT Hub NM3 <sup>8/7/8</sup> 3/4" NPT Hub EMERGENCY BATTERY OPTIONS EMIT 7W Emergency Battery Test Switch EMCR 10W Canopy Mounted EM EMRM 7W Remote EM EMEN 7W Remote with Enclosure	DF16 16" Diffuse PR16 16" Clear OP16 16" Opal	TF3 6" Frosted Diffuser	AFPFP Aluminum Fins w/ Decorative Perforations and 1-Metal Tier Ring AFSP Aluminum Decorative Arm with Slots and 1-Metal Tier Ring	SC2 Safety Cable Reflector to door	MW <sup>11</sup> Matte White MB <sup>11</sup> Matte Black PT <sup>11</sup> Platinum Silver CC Custom Color	FCHMA Field Cuttable Mounting Kit for Hang Mount Fixtures

**EXAMPLE:** PRAF16LX100L35KEX/CD36/PR16/AFPFP/MW

**NOTES:**  
<sup>1</sup> Nominal Delivered Lumens at 35K with PR16AFPFMW <sup>2</sup> Contact Factory for Additional Options <sup>3</sup> See Product Options Page For Details <sup>4</sup> See Mounting Page for Details on Components and Finishes <sup>5</sup> Specify Length in Inches: See Mounting Page for Available Lengths <sup>6</sup> Mounting Supplied by Others <sup>7</sup> Not Available with EMCR <sup>8</sup> 12" Leads Unless Specified <sup>9</sup> Fins and Tier Ring to Match Fixture Finish <sup>10</sup> Reference Color Sheet Located on Product Webpage for Full List of Available Colors <sup>11</sup> Standard Finishes <sup>12</sup> Field Cuttable Mounting Kit only Available with HM Stem



PROJECT: \_\_\_\_\_  
 QUANTITY: \_\_\_\_\_ TYPE: \_\_\_\_\_



# 16" PRISMATIC

## AF SERIES / FIXTURE OPTIONS



### STANDARD FINISHES

**MW**  
MATTE WHITE



**MB**  
MATTE BLACK



**PT**  
PLATINUM SILVER



### DECORATIVE ARMS

**AFPF**  
LASER CUT DECO ARM WITH HOLES

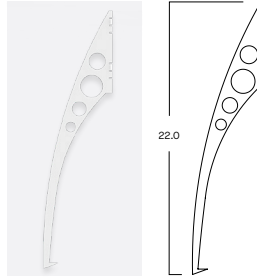

**AJSF**  
LASER CUT DECO ARM WITH SLOTS

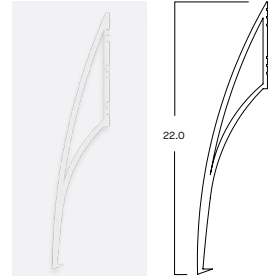

### MOUNTING TYPES

**HM / PM**  
HANG STRAIGHT / PENDANT



PRAF16LX SHOWN WITH PM

**CD**  
CORD / CABLE MOUNT



PRAF16LX SHOWN WITH CD

**HC**  
HOOK CORD



PRAF16LX SHOWN WITH HC

**NM**  
NO MOUNT



PRAF16LX SHOWN WITH NM



# MOUNTING & ACCESSORIES

SOME OPTIONS NOT AVAILABLE ON ALL FIXTURES. CONSULT SPECIFICATION SHEETS. SEE INDIVIDUAL SPECIFICATION SHEETS OR CONSULT FACTORY FOR ADDITIONAL INFORMATION. NOTE: THIS IS TYPICAL OF RLM SPECIFICATION FOR MOUNTING. INDIVIDUAL FIXTURES OR PROJECTS MAY HAVE SPECIALIZED REQUIREMENTS.



## ADDITIONS

### FS - Fusing

Slow blow type fuse protects fixture against voltage surges. Factory installed.



## SAFETY CABLE OPTIONS

### SC1 - Safety Cable

1/16" stainless steel safety cable for added support. Standard kit is 18" and double barrel locks are provided. Approved for California seismic requirements. Rated at 50 lbs.



### SC2 - Safety Cable, Refractor to Door

1/16" Stainless steel cable holds door to fixture

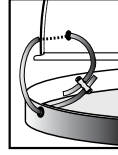

## ENCLOSURES

### TF3 - 6" Frosted Diffuser

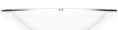

## OPTIONS

### DECORATIVE ARMS

**AFPF**-Aluminum Fins w/ Decorative Perforations and 1-Metal Tier Ring



**AFSF**-Aluminum Decorative Arm with Slots and 1-Metal Tier Ring



## MOUNTING TYPES

### HM\* - Hang Straight

45° SWIVEL 5/8" OD STEM - 3/8" IP

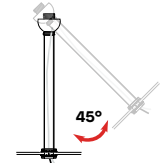

ORDER: **HM** (Length)  
SPECIFY LENGTH:  
**HM3** - 3"    **HM24** - 24"  
**HM6** - 6"    **HM36** - 36"  
**HM12** - 12"    **HM48** - 48"  
**HM18** - 18"    **HM72** - 72"  
**HMLC(XX)**  
Custom Length  
(Specify in Inches)

TO TRIM HM STEM IN FIELD ORDER FCHMA KIT.

### PM\* - Ridgid Pendant Mount

RIGID 5/8" OD STEM - 3/8" IP

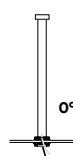

ORDER: **PM** (Length)  
SPECIFY LENGTH:  
**PM3** - 3"    **PM24** - 24"  
**PM6** - 6"    **PM36** - 36"  
**PM12** - 12"    **PM48** - 48"  
**PM18** - 18"    **PM72** - 72"  
**PMLC(XX)**  
Custom Length  
(Specify in Inches)

### CD - Cord / Cable Mount

SJ CORD WITH 1/16 SS CABLE



ORDER: **CD** (Length)  
SPECIFY LENGTH:  
**CD36** - 36"  
**CD72** - 72"  
**CD144** - 144"  
**CDLC(XX)**  
Custom Length  
(Specify in Inches)

### HC - Hook & Cord

FOR INDEPENDENT MOUNTING



ORDER: **HC** (Length)  
SPECIFY LENGTH:  
**HC36** - 36"  
**HC72** - 72"  
**HC144** - 144"  
**HCLC(XX)**  
Custom Length  
(Specify in Inches)

### NM2 - 1/2" NPT Hub NM3 - 3/4" NPT Hub

FOR INDEPENDENT MOUNTING



ORDER: **NMX** (Length)  
SPECIFY LENGTH:  
**NM2(12)** - 12" Leads are Standard  
**NM3(12)** - 12" Leads are Standard  
**NMXLC(XX)**  
Custom Length  
(Specify in Inches)

\*MAXIMUM ONE PIECE STEM LENGTH IS 72".  
LONGER LENGTHS ARE POSSIBLE USING MULTIPLE STEMS AND COUPLERS.

## MOUNTING OPTION

### FCHMA - Field Cuttable Mounting Kit For Hang Mount Fixtures



## EMERGENCY BATTERY OPTIONS

### EMCR - Large Driver Canopy For 10W Emergency Battery

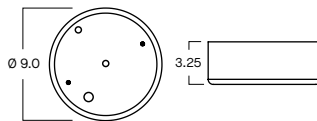

## REMOTE EMERGENCY BATTERY OPTIONS

### EMRM\* - 7W Remote Emergency Battery (50' Max)

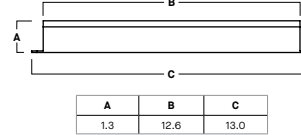

### EMEN\* - 7W Remote Emergency Battery with Enclosure (50' Max)

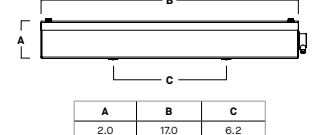

\*OTHER EM BATTERY SIZES AVAILABLE. CONSULT FACTORY



# 16" PRISMATIC

## AF SERIES / PHOTOMETRIC DATA



PRAF16LEDLX 140L 35K xx PR16 xx

CANDLEPOWER CURVE TEST SP-01511_3	INTENSITY CANDELA 0° AZIMUTH	ZONAL LUMENS	SINGLE UNIT: PERFORMANCE HORIZONTAL FOOTCANDLES INITIAL DOWNLIGHT ONLY				MULTIPLE UNITS: PERFORMANCE 80/50/20% REFLECTANCES HORIZONTAL FOOTCANDLES AND WATTS/SQ FT					
			Mounting Distance	FC at Beam Center	Diameter at Beam Angle	FC at Beam Edge	Ceiling Height	Fixture Spacing	RCR 2		RCR 4	
	0°	0° - 10° 1405 10%	8'	245 fc	8.8'	83 fc	18'	12"	88	0.68	110	0.99
	0°	0° - 20° 4980 36%	10'	157 fc	11.0'	53 fc	22'	14'	72	0.57	63	0.57
	5°	0° - 30° 9269 67%	12'	109 fc	13.2'	37 fc	26'	18"	47	0.37	41	0.37
	15°	0° - 40° 12000 87%	14'	80 fc	15.4'	27 fc	Delivered Illuminance Rating: (DIR)		128 FC per W/Sq. Ft.		111 FC per W/Sq. Ft.	
	25°	0° - 60° 13304 96%	16'	61 fc	17.6'	21 fc	3' Suspension Length to luminous aperture Square rooms used for multiple units: RCR 2: Length & Width = Ceiling Ht. - 5.5' x 5.00 RCR 4: Length & Width = Ceiling Ht. - 5.5' x 2.50 * Average Initial Footcandles at 2.5' Above Floor * Exceeds Spacing Ratio by 12% *** Exceeds Spacing Ratio by 2%					
	35°	0° - 80° 13656 99%	20'	39 fc	22.0'	13 fc						
	45°	0° - 90° 13687 99%	24'	27 fc	26.4'	9 fc						
	55°	90° 22	28'	20 fc	30.8'	7 fc						
	90°	Total 13815 100%										
	Delivered Lumens: 13815 Luminaire Watts: 107 LER: 129.11	CP at 0° (Nadir): 15698 CRI: 80+	Beam Angle: 58° Spacing Ratio: 0.86 Melanopic Ratio 0.55	Lumen Multiplier: 130L x .956 CCT Multiplier: 40K x 1.00, 30K x 0.978, 27K x 0.949								

PRAF16LEDLX 140L 35K xx PR16 TF3 xx

CANDLEPOWER CURVE TEST SP-01497_3	INTENSITY CANDELA 0° AZIMUTH	ZONAL LUMENS	SINGLE UNIT: PERFORMANCE HORIZONTAL FOOTCANDLES INITIAL DOWNLIGHT ONLY				MULTIPLE UNITS: PERFORMANCE 80/50/20% REFLECTANCES HORIZONTAL FOOTCANDLES AND WATTS/SQ FT					
			Mounting Distance	FC at Beam Center	Diameter at Beam Angle	FC at Beam Edge	Ceiling Height	Fixture Spacing	RCR 2		RCR 4	
	0°	0° - 10° 1249 10%	8'	211 fc	8.9'	71 fc	18'	12"	78	0.68	97	0.99
	0°	0° - 20° 4353 35%	10'	135 fc	11.1'	45 fc	22'	14'	65	0.57	56	0.57
	5°	0° - 30° 8090 65%	12'	94 fc	13.3'	31 fc	26'	18"	42	0.37	36	0.37
	15°	0° - 40° 10495 84%	14'	69 fc	15.5'	23 fc	Delivered Illuminance Rating: (DIR)		114 FC per W/Sq. Ft.		99 FC per W/Sq. Ft.	
	25°	0° - 60° 11707 94%	16'	53 fc	17.7'	18 fc	3' Suspension Length to luminous aperture Square rooms used for multiple units: RCR 2: Length & Width = Ceiling Ht. - 5.5' x 5.00 RCR 4: Length & Width = Ceiling Ht. - 5.5' x 2.50 * Average Initial Footcandles at 2.5' Above Floor * Exceeds Spacing Ratio by 10% *** Exceeds Spacing Ratio by 1%					
	35°	0° - 80° 12174 97%	20'	34 fc	22.2'	11 fc						
	45°	0° - 90° 12281 98%	24'	23 fc	26.6'	8 fc						
	55°	90° 63	28'	17 fc	31.0'	6 fc						
	90°	Total 12492 100%										
	Delivered Lumens: 12492 Luminaire Watts: 107 LER: 116.75	CP at 0° (Nadir): 13518 CRI: 80+	Beam Angle: 58° Spacing Ratio: 0.87 Melanopic Ratio 0.52	Lumen Multiplier: 130L x .950 CCT Multiplier: 40K x 1.00, 30K x 0.978, 27K x 0.949								

PRAF16LEDLX 140L 35K xx DF16 xx

CANDLEPOWER CURVE TEST SP-01532_3	INTENSITY CANDELA 0° AZIMUTH	ZONAL LUMENS	SINGLE UNIT: PERFORMANCE HORIZONTAL FOOTCANDLES INITIAL DOWNLIGHT ONLY				MULTIPLE UNITS: PERFORMANCE 80/50/20% REFLECTANCES HORIZONTAL FOOTCANDLES AND WATTS/SQ FT					
			Mounting Distance	FC at Beam Center	Diameter at Beam Angle	FC at Beam Edge	Ceiling Height	Fixture Spacing	RCR 2		RCR 4	
	0°	0° - 10° 832 6%	8'	138 fc	10.8'	39 fc	18'	12"	80	0.68	95	0.99
	0°	0° - 20° 3031 22%	10'	88 fc	13.5'	25 fc	22'	14'	66	0.57	54	0.57
	5°	0° - 30° 6122 44%	12'	61 fc	16.2'	17 fc	26'	18"	43	0.37	35	0.37
	15°	0° - 40° 8595 62%	14'	45 fc	18.9'	13 fc	Delivered Illuminance Rating: (DIR)		117 FC per W/Sq. Ft.		96 FC per W/Sq. Ft.	
	25°	0° - 60° 10849 78%	16'	34 fc	21.6'	10 fc	3' Suspension Length to luminous aperture Square rooms used for multiple units: RCR 2: Length & Width = Ceiling Ht. - 5.5' x 5.00 RCR 4: Length & Width = Ceiling Ht. - 5.5' x 2.50 * Average Initial Footcandles at 2.5' Above Floor					
	35°	0° - 80° 12458 89%	20'	22 fc	27.0'	6 fc						
	45°	0° - 90° 12965 93%	24'	15 fc	32.4'	4 fc						
	55°	90° 1182	28'	11 fc	37.8'	3 fc						
	90°	Total 13934 100%										
	Delivered Lumens: 13934 Luminaire Watts: 107 LER: 130.22	CP at 0° (Nadir): 8806 CRI: 80+	Beam Angle: 68° Spacing Ratio: 1.05 Melanopic Ratio 0.55	Lumen Multiplier: 130L x .946 CCT Multiplier: 40K x 1.00, 30K x 0.978, 27K x 0.949								



# 16" PRISMATIC

## AF SERIES / PHOTOMETRIC DATA



PRAF16LEDLX 140L 35K xx DF16 TF3 xx

CANDLEPOWER CURVE TEST SP-01531_3	INTENSITY CANDELA 0° AZIMUTH	ZONAL LUMENS	SINGLE UNIT: PERFORMANCE HORIZONTAL FOOTCANDLES INITIAL DOWNLIGHT ONLY	MULTIPLE UNITS: PERFORMANCE 80/50/20% REFLECTANCES HORIZONTAL FOOTCANDLES AND WATTS/SQ FT																																																																
	0°	0° - 10° 730 6%	<table border="1"> <thead> <tr> <th>Mounting Distance</th> <th>FC at Beam Center</th> <th>Diameter of Beam Angle</th> <th>FC at Beam Edge</th> </tr> </thead> <tbody> <tr><td>8'</td><td>121 fc</td><td>10.6'</td><td>35 fc</td></tr> <tr><td>10'</td><td>77 fc</td><td>13.3'</td><td>22 fc</td></tr> <tr><td>12'</td><td>54 fc</td><td>15.9'</td><td>15 fc</td></tr> <tr><td>14'</td><td>39 fc</td><td>18.6'</td><td>11 fc</td></tr> <tr><td>16'</td><td>30 fc</td><td>21.2'</td><td>9 fc</td></tr> <tr><td>20'</td><td>19 fc</td><td>26.6'</td><td>6 fc</td></tr> <tr><td>24'</td><td>13 fc</td><td>31.9'</td><td>4 fc</td></tr> <tr><td>28'</td><td>10 fc</td><td>37.2'</td><td>3 fc</td></tr> </tbody> </table>	Mounting Distance	FC at Beam Center	Diameter of Beam Angle	FC at Beam Edge	8'	121 fc	10.6'	35 fc	10'	77 fc	13.3'	22 fc	12'	54 fc	15.9'	15 fc	14'	39 fc	18.6'	11 fc	16'	30 fc	21.2'	9 fc	20'	19 fc	26.6'	6 fc	24'	13 fc	31.9'	4 fc	28'	10 fc	37.2'	3 fc	<table border="1"> <thead> <tr> <th rowspan="2">Ceiling Height</th> <th rowspan="2">Fixture Spacing</th> <th colspan="2">RCR 2</th> <th colspan="2">RCR 4</th> </tr> <tr> <th>FC *</th> <th>W/Sq. Ft.</th> <th>FC *</th> <th>W/Sq. Ft.</th> </tr> </thead> <tbody> <tr><td>18'</td><td>12'</td><td>70</td><td>0.68</td><td>83</td><td>0.99</td></tr> <tr><td>22'</td><td>14'</td><td>58</td><td>0.57</td><td>48</td><td>0.57</td></tr> <tr><td>26'</td><td>18'</td><td>38</td><td>0.37</td><td>31</td><td>0.37</td></tr> </tbody> </table>	Ceiling Height	Fixture Spacing	RCR 2		RCR 4		FC *	W/Sq. Ft.	FC *	W/Sq. Ft.	18'	12'	70	0.68	83	0.99	22'	14'	58	0.57	48	0.57	26'	18'	38	0.37	31	0.37
	Mounting Distance	FC at Beam Center		Diameter of Beam Angle	FC at Beam Edge																																																															
	8'	121 fc		10.6'	35 fc																																																															
	10'	77 fc		13.3'	22 fc																																																															
	12'	54 fc		15.9'	15 fc																																																															
	14'	39 fc		18.6'	11 fc																																																															
	16'	30 fc		21.2'	9 fc																																																															
	20'	19 fc		26.6'	6 fc																																																															
	24'	13 fc		31.9'	4 fc																																																															
	28'	10 fc		37.2'	3 fc																																																															
	Ceiling Height	Fixture Spacing		RCR 2		RCR 4																																																														
FC *			W/Sq. Ft.	FC *	W/Sq. Ft.																																																															
18'	12'	70	0.68	83	0.99																																																															
22'	14'	58	0.57	48	0.57																																																															
26'	18'	38	0.37	31	0.37																																																															
0° 7728	0° - 20° 2645 21%	<p>Delivered Lumens: 12420 Luminaire Watts: 107 LER: 116.07</p>	<p>CP at 0° (Nadir): 7728</p> <p>Beam Angle: 67° Spacing Ratio: 1.02 Melanopic Ratio: 0.52</p>	<p>Lumen Multiplier: 130L x .953 CCT Multiplier: 40K x 1.00, 30K x 0.978, 27K x 0.949</p>																																																																
5° 7649	0° - 30° 5269 42%																																																																			
15° 6865	0° - 40° 7379 59%																																																																			
25° 5848	0° - 60° 9390 76%																																																																			
35° 3405	0° - 80° 10898 88%																																																																			
45° 1316	0° - 90° 11423 92%																																																																			
55° 1036	Total 12420 100%																																																																			
90° 411																																																																				

PRAF-L-16LEDLX-140L-35K-E1-PR16-AFPF (or AFSF)-MW

CANDLEPOWER CURVE	INTENSITY	ZONAL LUMENS	SINGLE UNIT: PERFORMANCE INITIAL FOOTCANDLES BASED ON IES BEAM ANGLE	MULTIPLE UNITS: PERFORMANCE 80/50/20% REFLECTANCES INITIAL FOOTCANDLES AND WATTS PER SQUARE FOOT																																																																
	0.00°	0° - 10° 1,468 12%	<table border="1"> <thead> <tr> <th>Mounting Height AFF</th> <th>FC at Center on Floor</th> <th>Beam Diameter</th> <th>FC at Beam Edge</th> </tr> </thead> <tbody> <tr><td>10.0'</td><td>130 fc</td><td>10.7'</td><td>64 fc</td></tr> <tr><td>12.0'</td><td>90 fc</td><td>12.9'</td><td>45 fc</td></tr> <tr><td>14.0'</td><td>66 fc</td><td>15.0'</td><td>33 fc</td></tr> <tr><td>16.0'</td><td>51 fc</td><td>17.2'</td><td>25 fc</td></tr> <tr><td>20.0'</td><td>32 fc</td><td>21.5'</td><td>16 fc</td></tr> <tr><td>24.0'</td><td>23 fc</td><td>25.8'</td><td>11 fc</td></tr> <tr><td>28.0'</td><td>17 fc</td><td>30.1'</td><td>8 fc</td></tr> <tr><td>32.0'</td><td>13 fc</td><td>34.4'</td><td>6 fc</td></tr> </tbody> </table>	Mounting Height AFF	FC at Center on Floor	Beam Diameter	FC at Beam Edge	10.0'	130 fc	10.7'	64 fc	12.0'	90 fc	12.9'	45 fc	14.0'	66 fc	15.0'	33 fc	16.0'	51 fc	17.2'	25 fc	20.0'	32 fc	21.5'	16 fc	24.0'	23 fc	25.8'	11 fc	28.0'	17 fc	30.1'	8 fc	32.0'	13 fc	34.4'	6 fc	<table border="1"> <thead> <tr> <th rowspan="2">Ceiling Height</th> <th rowspan="2">Fixture Spacing</th> <th colspan="2">RCR 2</th> <th colspan="2">RCR 4</th> </tr> <tr> <th>FC *</th> <th>W/Sq. Ft.</th> <th>FC *</th> <th>W/Sq. Ft.</th> </tr> </thead> <tbody> <tr><td>22'</td><td>16'</td><td>49</td><td>0.47</td><td>61</td><td>0.67</td></tr> <tr><td>26'</td><td>18'</td><td>31</td><td>0.29</td><td>39</td><td>0.42</td></tr> <tr><td>32'</td><td>20'</td><td>26</td><td>0.25</td><td>23</td><td>0.25</td></tr> </tbody> </table>	Ceiling Height	Fixture Spacing	RCR 2		RCR 4		FC *	W/Sq. Ft.	FC *	W/Sq. Ft.	22'	16'	49	0.47	61	0.67	26'	18'	31	0.29	39	0.42	32'	20'	26	0.25	23	0.25
	Mounting Height AFF	FC at Center on Floor		Beam Diameter	FC at Beam Edge																																																															
	10.0'	130 fc		10.7'	64 fc																																																															
	12.0'	90 fc		12.9'	45 fc																																																															
	14.0'	66 fc		15.0'	33 fc																																																															
	16.0'	51 fc		17.2'	25 fc																																																															
	20.0'	32 fc		21.5'	16 fc																																																															
	24.0'	23 fc		25.8'	11 fc																																																															
	28.0'	17 fc		30.1'	8 fc																																																															
	32.0'	13 fc		34.4'	6 fc																																																															
	Ceiling Height	Fixture Spacing		RCR 2		RCR 4																																																														
FC *			W/Sq. Ft.	FC *	W/Sq. Ft.																																																															
22'	16'	49	0.47	61	0.67																																																															
26'	18'	31	0.29	39	0.42																																																															
32'	20'	26	0.25	23	0.25																																																															
0.00° 12,966	0° - 20° 4,591 38%	<p>Delivered Lumens: 11,976 Luminaire Watts: 111.89 LER: 107.03</p>	<p>CP at 0deg (Nadir): 12,966</p> <p>Beam Angle: 56.3° Spacing Ratio: 0.87</p>	<p>Lamp Multiplier: 65L x 0.47, 100L x 0.71, 130L x 0.93 CCT Multiplier: 27K x 0.959, 30K x 0.979, 40K x 1.03</p>																																																																
5.00° 12,913	0° - 30° 8,092 68%																																																																			
10.00° 12,640	0° - 40° 10,183 85%																																																																			
15.00° 11,552	0° - 60° 11,265 94%																																																																			
20.00° 9,689	0° - 80° 11,597 97%																																																																			
30.00° 5,746	0° - 90° 11,646 97%																																																																			
40.00° 1,465	Total 11,976 100%																																																																			
50.00° 535																																																																				
60.00° 308																																																																				
70.00° 156																																																																				
80.00° 59																																																																				
90.00° 42																																																																				

### HOW TO USE PERFORMANCE DATA

SINGLE UNIT	MULTIPLE UNITS
<p>Cone of Light of a single, symmetrical beam luminaire. Direct initial illumination (FC) and Beam Angle diameter directly beneath fixture; shown at different distances from aperture to horizontal plane. Calculated using Inverse Square Law.</p> $FC_H = CP \times (\cos \theta) \div D^2$ <p>Beam Diam. = <math>\frac{1}{2}</math> Beam Angle (Tan) x 2D</p> <ul style="list-style-type: none"> <li>- CP Candela at 0° (Nadir)</li> <li>- Cos <math>\theta</math> Cosine of <math>\theta</math> Angle</li> <li>- D Distance (Mounting Height AFF)</li> <li>- FC<sub>H</sub> Footcandles, Horizontal</li> <li>- Beam Angle Cone of light to 50% max. CP</li> <li>- Beam Diam. Pattern of light at Beam Angle</li> </ul>	<p>Square grid layout of multiple luminaires in unfurnished, square rooms of different proportions (Room Cavity Ratios) with 80/50/20% room surface reflectances. 4' Suspension Length to aperture. Initial average illumination (FC) calculated at 2.5' above floor, using Zonal Cavity Method. W/Sq. Ft. of layout shown for each ceiling height and RCR.</p> <p>Delivered Illuminance Rating (DIR*): System performance indicator expressed as ratio of approximate initial FC per W/Sq. Ft. delivered to horizontal plane below, for the range of ceiling heights indicated.</p> <ul style="list-style-type: none"> <li>- To estimate FC for Fixture Spacing that is different than shown (do not exceed Spacing Ratio): FC = Chart Spacing<sup>2</sup> ÷ Different Spacing<sup>2</sup> x Chart FC</li> <li>- To estimate Sq. Ft. per fixture for a specific target FC: Sq. Ft. / Fixture = Chart FC x Chart Spacing<sup>2</sup> ÷ Target FC</li> </ul> <ul style="list-style-type: none"> <li>- To estimate Fixture Quantity in a room: Fixture Qty. = Sq. Ft. of Rm. ÷ Sq. Ft. per fixture</li> <li>- To estimate Watts/Sq. Ft.: W/ Sq. Ft. = Luminaire Watts x Qty. ÷ Sq. Ft. of Rm.</li> </ul>

