

13" ROUND ACCENT DIRECT

STAGE-PRO SERIES



C1320YKFSXT - YOKE MOUNT

APPLICATION

13" round x 20" high XT series Stage Pro pendant for auditorium and area lighting. Features integral flared 3" deep snoot for additional cutoff.

FEATURES

Architectural high performance LED Cylinder luminaire. Designed to illuminate auditoriums, houses of worship and other spaces where LED color quality and control are required. This series offers .01% dim to black as well as DMX, ELV and DALI dimming. Rugged design with flexible mounting, finish and LED options make these extremely versatile fixtures. Quick change LED module with interchangeable optics for job site flexibility and fixture upgrade.

FINISH

Multi-stage polyester powder-coat process applied on our dedicated paint lines. See mounting and color pages for standard finishes. All exposed materials are chromate pretreated to resist corrosion.

ELECTRONICS

LED system features Xicato LED module with proprietary phosphor technology that provides consistent stable color with CCT control of +/- 100K over life of the light engine. Base CRI is 83 with 2-step MacAdam Ellipse binning. High CRI is 98 with 1 x 2-step MacAdam Ellipse binning. Variety of electronic 120V/277V and dimming drivers. DMX specified control will register as 4 individual unit loads on a DMX universe.

CONSTRUCTION

Housing constructed of .080 aluminum. Specular primary optical reflectors provide high efficiency illumination. Stainless steel hardware with galvanized steel brackets to resist corrosion.

CODE COMPLIANCE

BAA compliant. ETL certified to meet US and Canadian standards. Suitable for dry or damp locations. Manufactured and tested to UL standards No. 1598/8750.

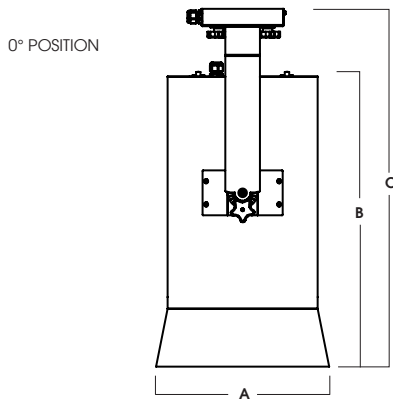

A	B	C
15.0 381.0 mm	25.0 635.0 mm	31.0 787.4 mm

Fixture Weight: 30.3 lbs

LUMENS / WATTAGE DATA				
PART NUMBER	SOURCE LUMENS ¹	DELIVERED LUMENS ²	SYSTEM WATTS ³	LPW
C1320YKFSXT52L	5200	3996	60.0	67
C1320YKFSXT80L	8000	6151	94.8	65
C1320YKFSXT120L	12000	9222	138.4	67
C1320YKFSXT160L	16000	11832	159.6	74
C1320YKFSXT200L	20000	15373	207.0	74

SERIES	LUMENS ¹	CCT	OPTICS	DRIVER/VOLTAGE ⁵	OPTIONS ⁸	TRIM	MOUNTING ⁹	FINISH ¹⁰	
C1320YKFSXT	52L	5200 Lm	83 CRI	XN 12°	EX Electronic Driver, 120V/277V DS10X 10%, 0-10V, 120V/277V DO10X 1%, 0-10V, 120V/277V DLTE1 ⁶ Lutron 2-Wire Forward Phase (MLV), 120V DL3EX ⁶ 1%, Lutron [®] EcoSystem [®] Fade, 120V/277V DALIX DALI Control DMXS ⁷ DMX Standard Configuration DMXC ⁷ DMX Non-Standard Custom	FS Fuse Holder and Fuse SC1 Safety Cable	MWI Matte White MBI Matte Black CCI Custom Color	SM Surface Mount	MW ¹¹ Matte White MB ¹¹ Matte Black PT ¹¹ Platinum Silver CC Custom Color
	80L	8000 Lm	27K 2700K	ND 25°					
	120L	12000 Lm	30K 3000K	MD 37°					
	160L	16000 Lm	35K 3500K	WD 53°					
	200L	20000 Lm	40K 4000K	XW 55°					
	98 CRI ⁴								
			27HK 2700K						
			30HK 3000K						
			35HK 3500K						
			40HK 4000K						
							EMERGENCY BATTERY OPTIONS		See Page 5 for Full Range of Color Options (83-90095)
							EMRM 7W Remote EM		
							EMEN 7W Remote with Enclosure		

EXAMPLE: C1320YKFSXT80L27KMDEX/MBI/SM/MB

NOTES:

1 Nominal Source Lumens At Any CCT 2 Nominal Delivered Lumens at 83 CRI at Any CCT with MD-MBI 3 At 83 CRI 4 120L Max 5 Contact Factory for Additional Options 6 200L Not Available with Lutron Drivers 7 Contact Factory 8 See Product Options Page for Details 9 See Mounting Page for Details on Components and Finishes 10 See Color Page for More Options/Consult Factory for Special Finishes 11 Standard Finishes



PROJECT: _____
TYPE: _____



Dimensions and values shown are nominal. Spectrum Lighting continually works to improve products and reserves the right to make changes which may alter the performance or appearance of products.

13" ROUND ACCENT DIRECT

STAGE-PRO SERIES / FIXTURE OPTIONS



STANDARD FINISHES

MW
MATTE WHITE



MB
MATTE BLACK



PT
PLATINUM SILVER

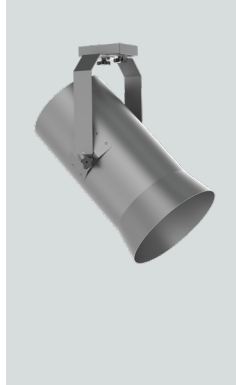

MOUNTING TYPES

YK
YOKE MOUNT



0° POSITION

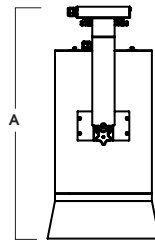

A
31.0
787.4 mm

45° POSITION

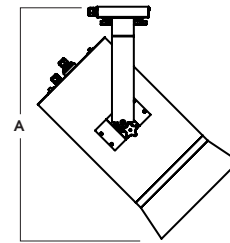

A
31.8
807.7 mm

90° TILT

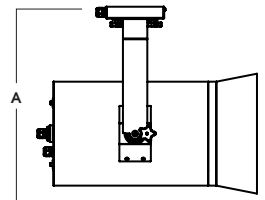

A
23.4
594.4 mm

EMERGENCY BATTERY OPTIONS

EMRM* - 7W REMOTE EMERGENCY BATTERY
(50' MAX)

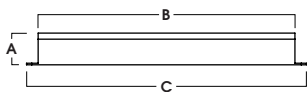

A	B	C
1.3	12.6	13.0

EMEN* - 7W REMOTE EMERGENCY BATTERY
WITH ENCLOSURE (50' MAX)

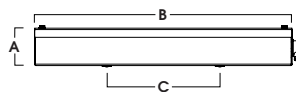

A	B	C
2.0	17.0	6.2

*OTHER EM BATTERY SIZES AVAILABLE. CONSULT FACTORY

13" ROUND ACCENT DIRECT

STAGE-PRO SERIES / PHOTOMETRIC DATA



C1320YKFSXT-200LxxK-WDEX-MBI

200L WIDE - 83 CRI

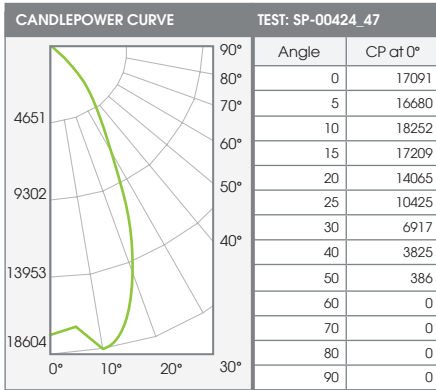

Beam Angle	Zonal Lumens	% of Total
0-10	1659	11%
0-20	6286	40%
0-30	11117	71%
0-40	14186	91%
0-60	15584	100%
0-80	15584	100%
0-90	15584	100%
Total Lumens	15584	100%

SINGLE UNIT: PERFORMANCE			
INITIAL FOOTCANDLES AND BEAM ANGLE DIAMETERS			
Mounting Height*	FC at Center	Diameter of Beam**	FC at Beam**
10'	171	10.0'	68
12'	119	12.0'	47
16'	67	16.0'	27
20'	43	20.0'	17
24'	30	24.0'	12
28'	22	28.0'	9
32'	17	32.0'	7
36'	13	36.0'	5

* From aperture to horizontal surface below.
** At IESNA defined Beam Angle, to 50% Max. CP.

Delivered Lumens: 15584 CP @ 0° (Nadir): 17091 Spacing Ratio: 0.9
 Luminaire Watts: 207 Beam Angle: 53.1° Output Multipliers: 52L x 0.25, 80L x 0.4, 120L x 0.62, 160L x 0.77
 LER: 75 CRI: 83

C1320YKFSXT-200LxxK-XWEX-MBI

200L XTRA WIDE - 83 CRI

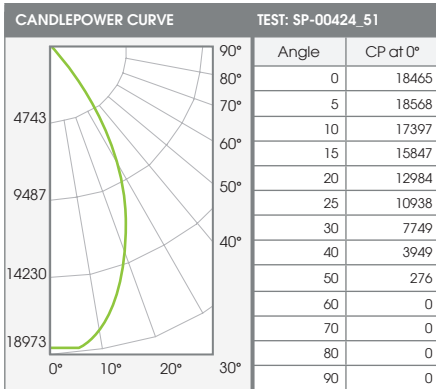

Beam Angle	Zonal Lumens	% of Total
0-10	1737	11%
0-20	6127	39%
0-30	11070	70%
0-40	14478	91%
0-60	15859	100%
0-80	15859	100%
0-90	15859	100%
Total Lumens	15859	100%

SINGLE UNIT: PERFORMANCE			
INITIAL FOOTCANDLES AND BEAM ANGLE DIAMETERS			
Mounting Height*	FC at Center	Diameter of Beam**	FC at Beam**
10'	190	10.3'	75
12'	132	12.4'	52
16'	74	16.5'	29
20'	47	20.6'	19
24'	33	24.7'	13
28'	24	28.8'	10
32'	19	33.0'	7
36'	15	37.1'	6

* From aperture to horizontal surface below.
** At IESNA defined Beam Angle, to 50% Max. CP.

Delivered Lumens: 15859 CP @ 0° (Nadir): 18465 Spacing Ratio: 0.86
 Luminaire Watts: 207 Beam Angle: 54.5° Output Multipliers: 52L x 0.25, 80L x 0.4, 120L x 0.62, 160L x 0.77
 LER: 77 CRI: 83

COLOR OPTIONS - POWDER COAT PAINT FINISHES

NOTE: NO PRINTED IMAGE CAN EQUAL THE EXACT COLOR OF FINISH ON METAL.
SEE INDIVIDUAL SPECIFICATION SHEETS OR CONSULT FACTORY FOR ADDITIONAL INFORMATION.



STANDARD CORD / STEM / CANOPY FINISHES

FIXTURE COLOR	STANDARD CORD COLOR	STANDARD CANOPY / STEM COLOR
Matte White, Textured White	Matte White	Matte White
Gloss White	Matte White	Gloss White
Matte Black, Textured Black	Matte Black	Matte Black
All Others	Matte Black	Same Color as Fixture
Custom Color	Contact Factory	Contact Factory

PAINT TIMES

TIER	COST	AVERAGE PAINT TIME*
Tier 1 - Standard Finishes	\$	⌚
Tier 2 - Typical Finishes	\$\$	⌚⌚
Custom Color	Contact Factory	Contact Factory

*CONTACT FACTORY FOR SPECIFIC PRODUCT LEAD TIMES

TIER 1 - STANDARD FINISHES

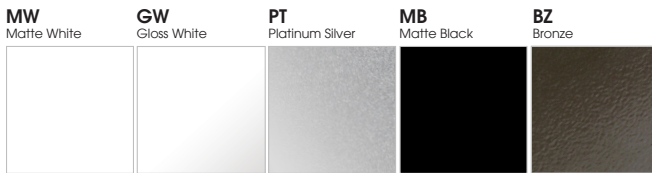

TIER 2 - TYPICAL FINISHES

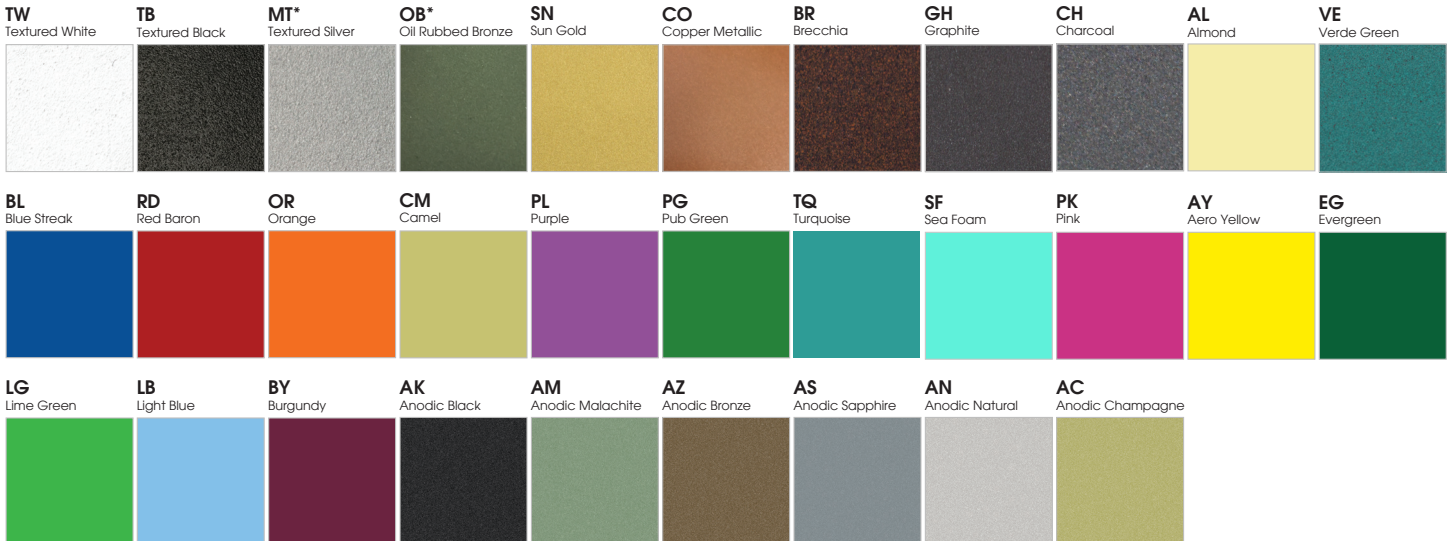

CUSTOM COLOR FINISHES

CONTACT FACTORY

CC
Custom Color



*UNAVAILABLE FOR WET LOCATION