

IF03

3" SQUARE RECESSED

Spectrum's Infinium 3" recessed square downlight series features multiple housings and variety of trims for accent and general illumination.

NOMINAL LUMENS / WATTAGE DATA				
PART NUMBER	CCT RANGE	DELIVERED LUMENS ¹	SYSTEM WATTS	LPW
IF03SMF 007 PC	835	359	7	49
IF03SMF 010 PC	835	503	9	54
IF03SMF 015 PC	835	700	12	57
IF03SMF 020 PC	835	898	15	60
IF03RMF 030 PC	835	1347	20.4	66

¹ Nominal Delivered Lumens at 835 DL FL GP MW MF

PROJECT: _____
 QUANTITY: _____ TYPE: _____

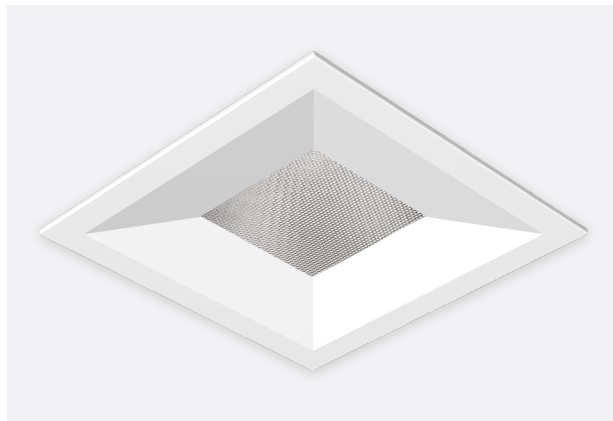

PRODUCT SELECTOR GUIDE

SERIES	TYPE	EMITTER	CRI/CCT	LUMENS	OPTIONS	DIMMING	MOUNTING	BATTERY	TRIM	BEAM	LENS	FINISH	FLANGE FINISH	OPTIONS	ADDITIONAL ACCESSORIES
IF03SMF	NC	PC	835	10		D12	B1		DL	NF	GP	MW	MF	WL	GRIF03S

FIXTURE HOUSING SPECIFICATION

SERIES	TYPE	EMITTER	CRI / CCT	LUMENS	OPTIONS	DIMMING	MOUNTING	BATTERY	
SHALLOW		PC	90 Minimum	07 359 Lm	PR 1.25" Ceiling Extension	N1 Non-Dimming Electronic Driver D1 1%, 0-10V	1 120V 2 277V	NC/IC B1 Expandable Bar Hangers RT BO No Bar Hangers	E1 7W Integral Battery ER 7W Remote Battery
IF03SMF	Flange		IC New Construction	10 503 Lm					
			IC New Construction	15 700 Lm					
			IC New Construction	20 ³ 898 Lm					
			IC New Construction	30 ³ 1347 Lm					
SUPER SHALLOW		80 CRI							
IF03SSF ¹	Flange	IC IC New Construction	827 2700K 830 3000K 835 3500K 840 4000K						

AVAILABLE TRIM / MODULE TYPES

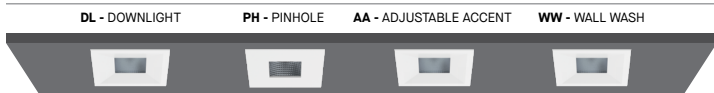

TRIM / MODULE SPECIFICATION

TRIM	BEAM	LENS	FINISH	FLANGE FINISH ⁹	OPTIONS
DL Downlight	SP Spot (25°)	GN ⁸ No Lens	MW Matte White	MF Matching Flange	WL ¹¹ Wet Location
PH Pinhole Downlight	NF Narrow Flood (31°)	GP Solite™ Micro Prism Lens	MB Matte Black	WF ¹⁰ White Flange	
	FL Flood (41°)	GC Clear Glass Lens	PT Platinum Silver		
	WF Wide Flood (53°)		CC Custom Color		
AA Adjustable Accent	NF Narrow Flood (32°)				
	FL Flood (38°)				
	WF Wide Flood (42°)				
WW Wall Wash	WF Wide Flood	LW Wall Wash Lens			

QUICK SHIP

SEPARATE

ADDITIONAL ACCESSORIES	
GOOF RING	
GRIF03S	MW Matte White
	MB Matte Black
	PT Platinum Silver
	CC Custom Color
BAR HANGERS	
B2	27" Solid Bar Hangers
B4	24" C-Channel Bar Hangers



FINISH**MW**
Matte White**MB**
Matte Black**PT**
Platinum Silver**CC**
Custom Color**PRODUCT FEATURES**

- Versatile shallow plenum 3" square recessed LED luminaire features downlight, adjustable accent, wall wash and pinhole downlight trim options with new construction, insulated ceiling and retrofit housings.
- Two-stage optical systems for smooth light distribution and focus control. Tool-less driver and j-box access. "Posi-lock" trim retention springs. All frames are capable of installation in ceiling thicknesses from 1/16" to 1" thick.

Trim Finish

- A variety of architectural trim finish options utilizing powdercoat colors. Matte White flange is an option for non-white finishes

Electronics

- LED module features high brightness Philips LEDs. 3-step MacAdam Ellipse binning and 80 and 90 CRI available. 0-10V or phase-cut dimming to 1%, standard. Variety of 120V/277V drivers available, consult factory. 2200K closely resembles candle light or high pressure sodium lamps.
- Variety of electronic 120/277V and Dimming options are available. Emergency backup version available as standard option.

Construction

- Housing/frame constructed of #20 ga. galvanized steel to resist corrosion. Self-flanged one piece die-cast aluminum trim is finished to specification. Passive machined aluminum heatsink.

Code Compliance

- ETL certified to meet US and Canadian standards. Suitable for dry or damp locations. Optional Wet Location. Manufactured and tested to UL standards No. 1598/8750. Insulated Ceiling (IC) options available.
- Designed, manufactured, and assembled in Fall River, MA, BAA compliant.
- Recyclable materials utilized wherever possible.

Quick Ship

- Quick Ship highlights products that can ship in 3 - 5 working days.

HOUSING DIMENSIONS

IF03SMF NC - New Construction

Non-IC rated, thermally protected frame-in kit for new construction. Non-IC designation requires insulation must be minimum of 3" from housing.

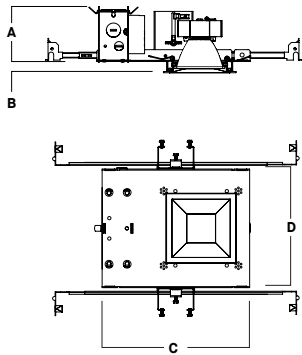

A	B	C	D
3.4	.625	9.5	7.6
86.4 mm	15.9 mm	241.3 mm	193.0 mm

Fixture Weight: 4.0 lbs Ceiling Cutout: 4.1" Sq

IF03SMF IC - IC New Construction

IC rated frame-in kit for new construction with direct insulation contact.

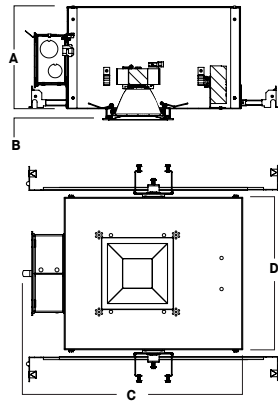

A	B	C	D
6.5	.625	13.2	9.5
165.1 mm	15.9 mm	335.3 mm	241.3 mm

Fixture Weight: 5.0 lbs Ceiling Cutout: 4.1" Sq

IF03SSF IC - Super Shallow IC New Construction

IC rated frame-in kit for new construction with direct insulation contact.

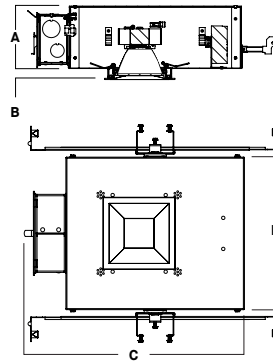

A	B	C	D
4.0	.625	13.2	9.5
101.6 mm	15.9 mm	335.3 mm	241.3 mm

Fixture Weight: 5.0 lbs Ceiling Cutout: 4.1" Sq

IF03SMF RT - Remodel Construction

Non-IC rated frame-in kit for existing construction. Non-IC designation requires insulation must be minimum of 3" from housing.

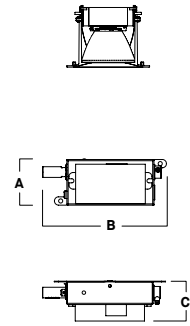

A	B	C
2.8	7.5	2.4
71.1 mm	190.5 mm	61.0 mm

Fixture Weight: 2.0 lbs Ceiling Cutout: 4" Sq

EMERGENCY BATTERY

EM - 3" EM Option

EM requires above ceiling access, supplied with remote mounted test switch. Not available in IC Housing.

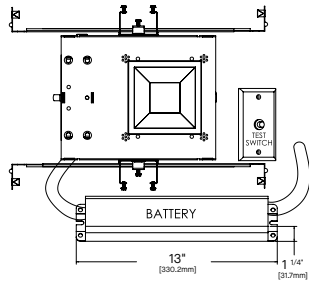

ADDITIONAL ACCESSORIES

GRIF03S - 3" Square Goof Ring

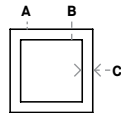

A	B	C
5.3 Sq	3.9 Sq	0.7
134.6 mm	99.1 mm	17.8 mm

OPTICS

SP - Spot (25°)



NF - Narrow Flood (31°)



FL - Flood (41°)



WF - Wide Flood (53°)



AA - Adjustable Accent



WW - Wall Wash



TRIM / MODULE DIMENSIONS

30L SHALLOW HOUSING (IF03SMF) TRIMS

DL - Downlight Shallow Flange

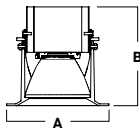

A	B
4.5	4.5
114.3 mm	114.3 mm

PH - Pinhole Flange

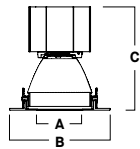

A	B	C
1.9	4.5	4.9
48.3 mm	114.3 mm	124.5 mm

AA - 30° Adjustable Shallow Flange

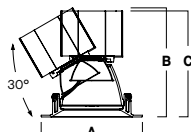

A	B	C
4.5	4.9	5.0
114.3 mm	124.5 mm	127.0 mm

WW - Wall Wash Flange

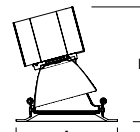

A	B
4.5	5.2
114.3 mm	132.1 mm

07L - 20L SHALLOW HOUSING (IF03SMF) TRIMS & SUPER SHALLOW HOUSING (IF03SSF) TRIMS

DL - Downlight Shallow Flange

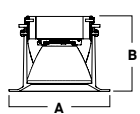

A	B
4.5	3.5
114.3 mm	88.9 mm

PH - Pinhole Flange

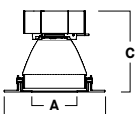

A	B	C
1.9	4.5	3.9
48.3 mm	114.3 mm	99.1 mm

AA - 30° Adjustable Shallow Flange

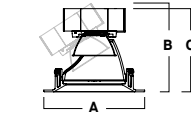

A	B	C
4.5	3.8	3.9
114.3 mm	96.5 mm	99.1 mm

WW - Wall Wash Flange

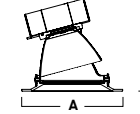

A	B
4.5	4.1
114.3 mm	104.1 mm

IF03SMx xx 835 020 DLSPGP MW - Shallow

CANDLEPOWER CURVE TEST SP-00764_2	INTENSITY CANDELA 0° AZIMUTH	ZONAL LUMENS	SINGLE UNIT: PERFORMANCE DIRECT FOOTCANDLES BASED ON DOWNLIGHT ONLY	MULTIPLE UNITS: PERFORMANCE 80/50/20% REFLECTANCES INITIAL FOOTCANDLES AND WATTS PER SQUARE FOOT																																								
	0°	0° - 10° 221 24%	Mounting Height AFF	<table border="1"> <thead> <tr> <th rowspan="2">Ceiling Height</th> <th rowspan="2">Fixture Spacing</th> <th colspan="2">RCR 4</th> <th colspan="2">RCR 6</th> </tr> <tr> <th>FC *</th> <th>W/Sq. Ft.</th> <th>FC *</th> <th>W/Sq. Ft.</th> </tr> </thead> <tbody> <tr> <td>18'</td> <td>4'</td> <td>46</td> <td>0.81</td> <td>42</td> <td>0.82</td> </tr> <tr> <td>22'</td> <td>6'</td> <td>23</td> <td>0.40</td> <td>18</td> <td>0.36</td> </tr> <tr> <td>26'</td> <td>8'</td> <td>12</td> <td>0.21</td> <td>13</td> <td>0.25</td> </tr> <tr> <td colspan="2">Delivered Illuminance Rating: (DIR)</td> <td colspan="2">57 FC per W/Sq. Ft.</td> <td colspan="2">52 FC per W/Sq. Ft.</td> </tr> <tr> <td colspan="6">Recessed mounting Square rooms used for multiple units: RCR 4: Length & Width = Ceiling Ht. - 2.5' x 2.50 RCR 6: Length & Width = Ceiling Ht. - 2.5' x 1.66 * Average Footcandles at 2.5' Above Floor</td> </tr> </tbody> </table>	Ceiling Height	Fixture Spacing	RCR 4		RCR 6		FC *	W/Sq. Ft.	FC *	W/Sq. Ft.	18'	4'	46	0.81	42	0.82	22'	6'	23	0.40	18	0.36	26'	8'	12	0.21	13	0.25	Delivered Illuminance Rating: (DIR)		57 FC per W/Sq. Ft.		52 FC per W/Sq. Ft.		Recessed mounting Square rooms used for multiple units: RCR 4: Length & Width = Ceiling Ht. - 2.5' x 2.50 RCR 6: Length & Width = Ceiling Ht. - 2.5' x 1.66 * Average Footcandles at 2.5' Above Floor					
	Ceiling Height	Fixture Spacing	RCR 4				RCR 6																																					
			FC *		W/Sq. Ft.	FC *	W/Sq. Ft.																																					
	18'	4'	46		0.81	42	0.82																																					
	22'	6'	23		0.40	18	0.36																																					
	26'	8'	12		0.21	13	0.25																																					
	Delivered Illuminance Rating: (DIR)		57 FC per W/Sq. Ft.		52 FC per W/Sq. Ft.																																							
	Recessed mounting Square rooms used for multiple units: RCR 4: Length & Width = Ceiling Ht. - 2.5' x 2.50 RCR 6: Length & Width = Ceiling Ht. - 2.5' x 1.66 * Average Footcandles at 2.5' Above Floor																																											
	0° 2881	0° - 20° 550 59%	8' 45 fc 3.6' 21 fc																																									
	5° 2475	0° - 30° 770 82%	10' 29 fc 4.5' 13 fc																																									
	15° 1206	0° - 40° 847 90%	12' 20 fc 5.4' 9 fc																																									
25° 446	0° - 60° 904 97%	14' 15 fc 6.4' 7 fc																																										
35° 78	0° - 80° 934 100%	16' 11 fc 7.3' 5 fc																																										
45° 25	0° - 90° 936 100%	20' 7 fc 9.1' 3 fc																																										
55° 36	Total 936 100%	24' 5 fc 10.9' 2 fc																																										
90° 1		28' 4 fc 12.7' 2 fc																																										

Delivered Lumens: 936
Luminaire Watts: 15
LER: 62.40

CP at 0° (Nadir): 2881
CRI: 80

Beam Angle: 25°
Spacing Ratio: 0.42

Lumen Multiplier: 07L x 0.40, 10L x 0.56, 15L x 0.78
CCT Multiplier: 40K x 1.03

IF03SMxxx835020/DLNFPGMWMF - Shallow

CANDLEPOWER CURVE TEST SP-00763_2	INTENSITY CANDELA 0° AZIMUTH	ZONAL LUMENS	SINGLE UNIT: PERFORMANCE DIRECT FOOTCANDLES BASED ON DOWNLIGHT ONLY	MULTIPLE UNITS: PERFORMANCE 80/50/20% REFLECTANCES INITIAL FOOTCANDLES AND WATTS PER SQUARE FOOT																																								
	0°	0° - 10° 192 21%	Mounting Height AFF	<table border="1"> <thead> <tr> <th rowspan="2">Ceiling Height</th> <th rowspan="2">Fixture Spacing</th> <th colspan="2">RCR 3</th> <th colspan="2">RCR 5</th> </tr> <tr> <th>FC *</th> <th>W/Sq. Ft.</th> <th>FC *</th> <th>W/Sq. Ft.</th> </tr> </thead> <tbody> <tr> <td>14'</td> <td>6"</td> <td>22</td> <td>0.37</td> <td>24</td> <td>0.45</td> </tr> <tr> <td>18'</td> <td>8"</td> <td>12</td> <td>0.20</td> <td>13</td> <td>0.25</td> </tr> <tr> <td>22'</td> <td>10"</td> <td>8</td> <td>0.13</td> <td>8</td> <td>0.16</td> </tr> <tr> <td colspan="2">Delivered Illuminance Rating: (DIR)</td> <td colspan="2">59 FC per W/Sq. Ft.</td> <td colspan="2">53 FC per W/Sq. Ft.</td> </tr> <tr> <td colspan="6">Recessed mounting Square rooms used for multiple units: RCR 3: Length & Width = Ceiling Ht. - 2.5' x 3.33 RCR 5: Length & Width = Ceiling Ht. - 2.5' x 2.00 * Average Footcandles at 2.5' Above Floor ** Exceeds Spacing Ratio by 2% *** Exceeds Spacing Ratio by 1% **** Exceeds Spacing Ratio by 1%</td> </tr> </tbody> </table>	Ceiling Height	Fixture Spacing	RCR 3		RCR 5		FC *	W/Sq. Ft.	FC *	W/Sq. Ft.	14'	6"	22	0.37	24	0.45	18'	8"	12	0.20	13	0.25	22'	10"	8	0.13	8	0.16	Delivered Illuminance Rating: (DIR)		59 FC per W/Sq. Ft.		53 FC per W/Sq. Ft.		Recessed mounting Square rooms used for multiple units: RCR 3: Length & Width = Ceiling Ht. - 2.5' x 3.33 RCR 5: Length & Width = Ceiling Ht. - 2.5' x 2.00 * Average Footcandles at 2.5' Above Floor ** Exceeds Spacing Ratio by 2% *** Exceeds Spacing Ratio by 1% **** Exceeds Spacing Ratio by 1%					
	Ceiling Height	Fixture Spacing	RCR 3				RCR 5																																					
			FC *		W/Sq. Ft.	FC *	W/Sq. Ft.																																					
	14'	6"	22		0.37	24	0.45																																					
	18'	8"	12		0.20	13	0.25																																					
	22'	10"	8		0.13	8	0.16																																					
	Delivered Illuminance Rating: (DIR)		59 FC per W/Sq. Ft.		53 FC per W/Sq. Ft.																																							
	Recessed mounting Square rooms used for multiple units: RCR 3: Length & Width = Ceiling Ht. - 2.5' x 3.33 RCR 5: Length & Width = Ceiling Ht. - 2.5' x 2.00 * Average Footcandles at 2.5' Above Floor ** Exceeds Spacing Ratio by 2% *** Exceeds Spacing Ratio by 1% **** Exceeds Spacing Ratio by 1%																																											
	0° 2306	0° - 20° 524 56%	8' 36 fc 4.5' 16 fc																																									
	5° 2133	0° - 30° 758 82%	10' 23 fc 5.7' 10 fc																																									
	15° 1218	0° - 40° 844 91%	12' 16 fc 6.8' 7 fc																																									
25° 492	0° - 60° 897 97%	14' 12 fc 8.0' 5 fc																																										
35° 92	0° - 80° 926 100%	16' 9 fc 9.1' 4 fc																																										
45° 31	0° - 90° 928 100%	20' 6 fc 11.4' 3 fc																																										
55° 23	Total 928 100%	24' 4 fc 13.6' 2 fc																																										
90° 1		28' 3 fc 15.9' 1 fc																																										

Delivered Lumens: 928
Luminaire Watts: 15
LER: 61.87

CP at 0° (Nadir): 2306
CRI: 80

Beam Angle: 31°
Spacing Ratio: 0.51

Lumen Multiplier: 07L x 0.40, 10L x 0.56, 15L x 0.78
CCT Multiplier: 40K x 1.03

IF03SMx xx 835 020 DLFLGP MW - Shallow

CANDLEPOWER CURVE TEST SP-00762_2	INTENSITY CANDELA 0° AZIMUTH	ZONAL LUMENS	SINGLE UNIT: PERFORMANCE DIRECT FOOTCANDLES BASED ON DOWNLIGHT ONLY	MULTIPLE UNITS: PERFORMANCE 80/50/20% REFLECTANCES INITIAL FOOTCANDLES AND WATTS PER SQUARE FOOT																																								
	0°	0° - 10° 133 15%	Mounting Height AFF	<table border="1"> <thead> <tr> <th rowspan="2">Ceiling Height</th> <th rowspan="2">Fixture Spacing</th> <th colspan="2">RCR 3</th> <th colspan="2">RCR 5</th> </tr> <tr> <th>FC *</th> <th>W/Sq. Ft.</th> <th>FC *</th> <th>W/Sq. Ft.</th> </tr> </thead> <tbody> <tr> <td>14'</td> <td>6'</td> <td>21</td> <td>0.37</td> <td>22</td> <td>0.45</td> </tr> <tr> <td>18'</td> <td>8'</td> <td>11</td> <td>0.20</td> <td>12</td> <td>0.25</td> </tr> <tr> <td>22'</td> <td>10'</td> <td>7</td> <td>0.13</td> <td>8</td> <td>0.16</td> </tr> <tr> <td colspan="2">Delivered Illuminance Rating: (DIR)</td> <td colspan="2">56 FC per W/Sq. Ft.</td> <td colspan="2">50 FC per W/Sq. Ft.</td> </tr> <tr> <td colspan="6">Recessed mounting Square rooms used for multiple units: RCR 3: Length & Width = Ceiling Ht. - 2.5' x 3.33 RCR 5: Length & Width = Ceiling Ht. - 2.5' x 2.00 * Average Footcandles at 2.5' Above Floor</td> </tr> </tbody> </table>	Ceiling Height	Fixture Spacing	RCR 3		RCR 5		FC *	W/Sq. Ft.	FC *	W/Sq. Ft.	14'	6'	21	0.37	22	0.45	18'	8'	11	0.20	12	0.25	22'	10'	7	0.13	8	0.16	Delivered Illuminance Rating: (DIR)		56 FC per W/Sq. Ft.		50 FC per W/Sq. Ft.		Recessed mounting Square rooms used for multiple units: RCR 3: Length & Width = Ceiling Ht. - 2.5' x 3.33 RCR 5: Length & Width = Ceiling Ht. - 2.5' x 2.00 * Average Footcandles at 2.5' Above Floor					
	Ceiling Height	Fixture Spacing	RCR 3				RCR 5																																					
			FC *		W/Sq. Ft.	FC *	W/Sq. Ft.																																					
	14'	6'	21		0.37	22	0.45																																					
	18'	8'	11		0.20	12	0.25																																					
	22'	10'	7		0.13	8	0.16																																					
	Delivered Illuminance Rating: (DIR)		56 FC per W/Sq. Ft.		50 FC per W/Sq. Ft.																																							
	Recessed mounting Square rooms used for multiple units: RCR 3: Length & Width = Ceiling Ht. - 2.5' x 3.33 RCR 5: Length & Width = Ceiling Ht. - 2.5' x 2.00 * Average Footcandles at 2.5' Above Floor																																											
	0° 1480	0° - 20° 420 47%	8' 23 fc 6.0' 10 fc																																									
	5° 1426	0° - 30° 661 74%	10' 15 fc 7.5' 6 fc																																									
	15° 1039	0° - 40° 779 87%	12' 10 fc 9.0' 4 fc																																									
25° 501	0° - 60° 862 96%	14' 8 fc 10.4' 3 fc																																										
35° 168	0° - 80° 895 100%	16' 6 fc 11.9' 2 fc																																										
45° 62	0° - 90° 898 100%	20' 4 fc 14.9' 2 fc																																										
55° 34	Total 898 100%	24' 3 fc 17.9' 1 fc																																										
90° 1		28' 2 fc 20.9' 1 fc																																										

Delivered Lumens: 898
Luminaire Watts: 15
LER: 59.87

CP at 0° (Nadir): 1480
CRI: 80

Beam Angle: 41°
Spacing Ratio: 0.65

Lumen Multiplier: 07L x 0.40, 10L x 0.56, 15L x 0.78
CCT Multiplier: 40K x 1.03

IF03SMx xx 835 020 DLWFGP MW - Shallow

CANDLEPOWER CURVE TEST SP-00765_2	INTENSITY CANDELA 0° AZIMUTH	ZONAL LUMENS		SINGLE UNIT: PERFORMANCE DIRECT FOOTCANDLES BASED ON DOWNLIGHT ONLY				MULTIPLE UNITS: PERFORMANCE 80/50/20% REFLECTANCES INITIAL FOOTCANDLES AND WATTS PER SQUARE FOOT							
		0°	0° - 10°	90	10%	Mounting Height AFF	FC at Center on Floor	Beam Diameter	FC at Beam Edge	Ceiling Height	Fixture Spacing	RCR 2		RCR 4	
	0°	942	0° - 10°	90	10%	8'	15 fc	8.0'	5 fc	10'	6'	23	0.38	20	0.38
	5°	934	0° - 20°	322	36%	10'	9 fc	10.0'	3 fc	14'	8'	13	0.22	8	0.16
	15°	832	0° - 30°	573	63%	12'	7 fc	12.0'	2 fc	18'	10'	10	0.16	8	0.16
	25°	528	0° - 40°	738	82%	14'	5 fc	14.0'	2 fc	Delivered Illuminance Rating: (DIR)		60 FC per W/Sq. Ft.		51 FC per W/Sq. Ft.	
	35°	247	0° - 60°	873	97%	16'	4 fc	16.0'	1 fc	Recessed mounting Square rooms used for multiple units: RCR 2: Length & Width = Ceiling Ht. - 2.5' x 5.00 RCR 4: Length & Width = Ceiling Ht. - 2.5' x 2.50 * Average Footcandles at 2.5' Above Floor					
	45°	113	0° - 80°	903	100%	20'	2 fc	20.0'	1 fc						
	55°	50	0° - 90°	905	100%	24'	2 fc	24.1'	1 fc						
	90°	1	Total	905	100%	28'	1 fc	28.1'	0 fc						

Delivered Lumens: 905
Luminaire Watts: 15
LER: 60.33

CP at 0° (Nadir): 942
CRI: 80

Beam Angle: 53°
Spacing Ratio: 0.84

Lumen Multiplier: 07L x 0.40, 10L x 0.56, 15L x 0.78
CCT Multiplier: 40K x 1.03

See Page 1 for System Watts for all outputs

IF03SMx xx PC 835 020 WW WF LW MW - Wall Wash, Shallow

CANDLEPOWER CURVE
TEST SP-00850

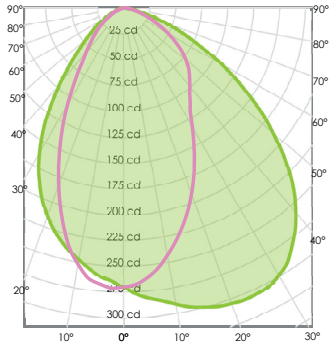

PERFORMANCE SUMMARY

Delivered Lumens: 452
 Luminaire Watts: 15
 LER: 30.13
 CP at 0deg (Nadir): 270
 CRI: 80+
 Lumen Multiplier: 07L x 0.40, 10L x 0.56, 15L x 0.78
 CCT Multiplier: 27K x 0.95, 30K x 0.98, 40K x 1.03

REFERENCE DIAGRAM

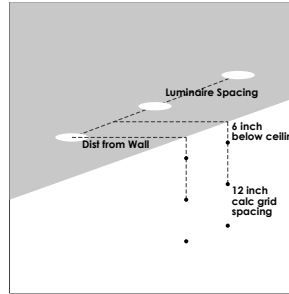

PERFORMANCE DATA - INITIAL ILLUMINATION (FOOTCANDLES) ON WALL - DIRECT LIGHT ONLY

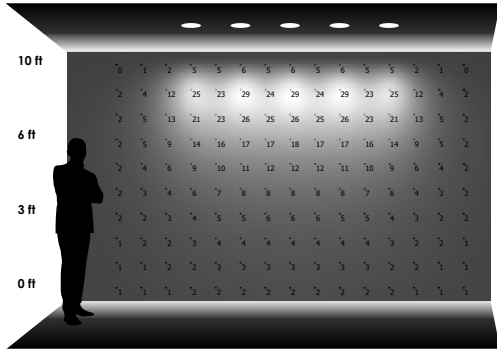

5 LUMINAIRES
2' away from wall
2' between luminaires

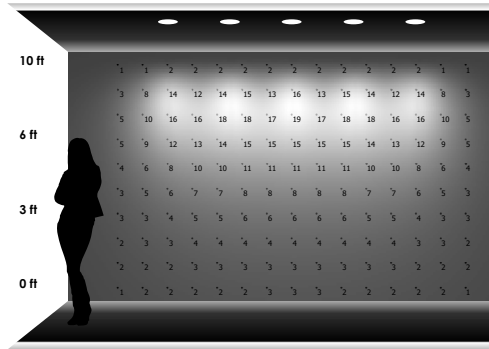

5 LUMINAIRES
2'-6" away from wall
2'-6" between luminaires



5 LUMINAIRES
3' away from wall
3' between luminaires

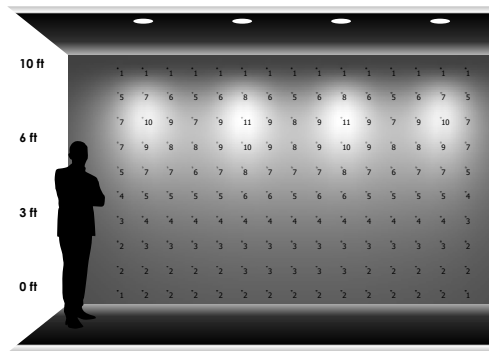

4 LUMINAIRES
3' away from wall
4' between luminaires

IF03SMx xx PC 835 030 DLSPGP MW - Shallow

CANDLEPOWER CURVE TEST SP-00764_2_M-30L	INTENSITY CANDELA 0° AZIMUTH	ZONAL LUMENS	SINGLE UNIT: PERFORMANCE DIRECT FOOTCANDLES BASED ON DOWNLIGHT ONLY	MULTIPLE UNITS: PERFORMANCE 80/50/20% REFLECTANCES INITIAL FOOTCANDLES AND WATTS PER SQUARE FOOT																																								
	0°	0° - 10° 331 24%	Mounting Height AFF	<table border="1"> <thead> <tr> <th rowspan="2">Ceiling Height</th> <th rowspan="2">Fixture Spacing</th> <th colspan="2">RCR 4</th> <th colspan="2">RCR 6</th> </tr> <tr> <th>FC *</th> <th>W/Sq. Ft.</th> <th>FC *</th> <th>W/Sq. Ft.</th> </tr> </thead> <tbody> <tr> <td>18'</td> <td>4'</td> <td>69</td> <td>1.10</td> <td>63</td> <td>1.11</td> </tr> <tr> <td>22'</td> <td>6'</td> <td>34</td> <td>0.55</td> <td>28</td> <td>0.49</td> </tr> <tr> <td>26'</td> <td>8'</td> <td>18</td> <td>0.29</td> <td>19</td> <td>0.34</td> </tr> <tr> <td colspan="2">Delivered Illuminance Rating: (DIR)</td> <td colspan="2">63 FC per W/Sq. Ft.</td> <td colspan="2">57 FC per W/Sq. Ft.</td> </tr> <tr> <td colspan="6">Recessed mounting Square rooms used for multiple units: RCR 4: Length & Width = Ceiling Ht. - 2.5' x 2.50 RCR 6: Length & Width = Ceiling Ht. - 2.5' x 1.66 * Average Footcandles at 2.5' Above Floor</td> </tr> </tbody> </table>	Ceiling Height	Fixture Spacing	RCR 4		RCR 6		FC *	W/Sq. Ft.	FC *	W/Sq. Ft.	18'	4'	69	1.10	63	1.11	22'	6'	34	0.55	28	0.49	26'	8'	18	0.29	19	0.34	Delivered Illuminance Rating: (DIR)		63 FC per W/Sq. Ft.		57 FC per W/Sq. Ft.		Recessed mounting Square rooms used for multiple units: RCR 4: Length & Width = Ceiling Ht. - 2.5' x 2.50 RCR 6: Length & Width = Ceiling Ht. - 2.5' x 1.66 * Average Footcandles at 2.5' Above Floor					
	Ceiling Height	Fixture Spacing	RCR 4				RCR 6																																					
			FC *		W/Sq. Ft.	FC *	W/Sq. Ft.																																					
	18'	4'	69		1.10	63	1.11																																					
	22'	6'	34		0.55	28	0.49																																					
	26'	8'	18		0.29	19	0.34																																					
	Delivered Illuminance Rating: (DIR)		63 FC per W/Sq. Ft.		57 FC per W/Sq. Ft.																																							
	Recessed mounting Square rooms used for multiple units: RCR 4: Length & Width = Ceiling Ht. - 2.5' x 2.50 RCR 6: Length & Width = Ceiling Ht. - 2.5' x 1.66 * Average Footcandles at 2.5' Above Floor																																											
	0° 4322	0° - 20° 824 59%	10' 43 fc 4.5' 20 fc																																									
	5° 3712	0° - 30° 1155 82%	12' 30 fc 5.4' 14 fc																																									
15° 1809	0° - 40° 1270 90%	14' 22 fc 6.4' 10 fc																																										
25° 668	0° - 60° 1356 97%	16' 17 fc 7.3' 8 fc																																										
35° 116	0° - 80° 1401 100%	20' 11 fc 9.1' 5 fc																																										
45° 37	0° - 90° 1404 100%	24' 8 fc 10.9' 3 fc																																										
55° 53	Total 1405 100%	28' 6 fc 12.7' 3 fc																																										
90° 2		32' 4 fc 14.5' 2 fc																																										

Delivered Lumens: 1405
Luminaire Watts: 20.4
LER: 68.87

CP at 0° (Nadir): 4322
CRI: 80

Beam Angle: 25°
Spacing Ratio: 0.42

Lumen Multiplier: N/A, 30L only
CCT Multiplier: 27K x 0.96, 30K x 0.98, 40K x 1.04
27HK x 0.87, 30HK x 0.81

IF03SMx xx PC 835 030 DLNFGP MW - Shallow

CANDLEPOWER CURVE TEST SP-00763_2_M-30L	INTENSITY CANDELA 0° AZIMUTH	ZONAL LUMENS	SINGLE UNIT: PERFORMANCE DIRECT FOOTCANDLES BASED ON DOWNLIGHT ONLY	MULTIPLE UNITS: PERFORMANCE 80/50/20% REFLECTANCES INITIAL FOOTCANDLES AND WATTS PER SQUARE FOOT																																								
	0°	0° - 10° 288 21%	Mounting Height AFF	<table border="1"> <thead> <tr> <th rowspan="2">Ceiling Height</th> <th rowspan="2">Fixture Spacing</th> <th colspan="2">RCR 3</th> <th colspan="2">RCR 5</th> </tr> <tr> <th>FC *</th> <th>W/Sq. Ft.</th> <th>FC *</th> <th>W/Sq. Ft.</th> </tr> </thead> <tbody> <tr> <td>14'</td> <td>6'</td> <td>33</td> <td>0.50</td> <td>36</td> <td>0.62</td> </tr> <tr> <td>18'</td> <td>8'</td> <td>18</td> <td>0.28</td> <td>20</td> <td>0.34</td> </tr> <tr> <td>22'</td> <td>10'</td> <td>11</td> <td>0.17</td> <td>13</td> <td>0.21</td> </tr> <tr> <td colspan="2">Delivered Illuminance Rating: (DIR)</td> <td colspan="2">65 FC per W/Sq. Ft.</td> <td colspan="2">59 FC per W/Sq. Ft.</td> </tr> <tr> <td colspan="6">Recessed mounting Square rooms used for multiple units: RCR 3: Length & Width = Ceiling Ht. - 2.5' x 3.33 RCR 5: Length & Width = Ceiling Ht. - 2.5' x 2.00 * Average Footcandles at 2.5' Above Floor ** Exceeds Spacing Ratio by 2% *** Exceeds Spacing Ratio by 1%</td> </tr> </tbody> </table>	Ceiling Height	Fixture Spacing	RCR 3		RCR 5		FC *	W/Sq. Ft.	FC *	W/Sq. Ft.	14'	6'	33	0.50	36	0.62	18'	8'	18	0.28	20	0.34	22'	10'	11	0.17	13	0.21	Delivered Illuminance Rating: (DIR)		65 FC per W/Sq. Ft.		59 FC per W/Sq. Ft.		Recessed mounting Square rooms used for multiple units: RCR 3: Length & Width = Ceiling Ht. - 2.5' x 3.33 RCR 5: Length & Width = Ceiling Ht. - 2.5' x 2.00 * Average Footcandles at 2.5' Above Floor ** Exceeds Spacing Ratio by 2% *** Exceeds Spacing Ratio by 1%					
	Ceiling Height	Fixture Spacing	RCR 3				RCR 5																																					
			FC *		W/Sq. Ft.	FC *	W/Sq. Ft.																																					
	14'	6'	33		0.50	36	0.62																																					
	18'	8'	18		0.28	20	0.34																																					
	22'	10'	11		0.17	13	0.21																																					
	Delivered Illuminance Rating: (DIR)		65 FC per W/Sq. Ft.		59 FC per W/Sq. Ft.																																							
	Recessed mounting Square rooms used for multiple units: RCR 3: Length & Width = Ceiling Ht. - 2.5' x 3.33 RCR 5: Length & Width = Ceiling Ht. - 2.5' x 2.00 * Average Footcandles at 2.5' Above Floor ** Exceeds Spacing Ratio by 2% *** Exceeds Spacing Ratio by 1%																																											
	0° 3460	0° - 20° 787 56%	8' 54 fc 4.5' 24 fc																																									
	5° 3200	0° - 30° 1138 82%	10' 35 fc 5.7' 15 fc																																									
15° 1827	0° - 40° 1266 91%	12' 24 fc 6.8' 11 fc																																										
25° 738	0° - 60° 1345 97%	14' 18 fc 8.0' 8 fc																																										
35° 138	0° - 80° 1389 100%	16' 14 fc 9.1' 6 fc																																										
45° 47	0° - 90° 1393 100%	20' 9 fc 11.4' 4 fc																																										
55° 35	Total 1393 100%	24' 6 fc 13.6' 3 fc																																										
90° 2		28' 4 fc 15.9' 2 fc																																										

Delivered Lumens: 1393
Luminaire Watts: 20.4
LER: 68.28

CP at 0° (Nadir): 3460
CRI: 80

Beam Angle: 31°
Spacing Ratio: 0.51

Lumen Multiplier: N/A, 30L only
CCT Multiplier: 27K x 0.96, 30K x 0.98, 40K x 1.04
27HK x 0.87, 30HK x 0.81

IF03SMx xx PC 835 030 DFLGP MW - Shallow

CANDLEPOWER CURVE TEST SP-00762_2_M-30L	INTENSITY CANDELA 0° AZIMUTH	ZONAL LUMENS	SINGLE UNIT: PERFORMANCE DIRECT FOOTCANDLES BASED ON DOWNLIGHT ONLY	MULTIPLE UNITS: PERFORMANCE 80/50/20% REFLECTANCES INITIAL FOOTCANDLES AND WATTS PER SQUARE FOOT																																								
	0°	0° - 10° 200 15%	Mounting Height AFF	<table border="1"> <thead> <tr> <th rowspan="2">Ceiling Height</th> <th rowspan="2">Fixture Spacing</th> <th colspan="2">RCR 3</th> <th colspan="2">RCR 5</th> </tr> <tr> <th>FC *</th> <th>W/Sq. Ft.</th> <th>FC *</th> <th>W/Sq. Ft.</th> </tr> </thead> <tbody> <tr> <td>14'</td> <td>6'</td> <td>31</td> <td>0.50</td> <td>34</td> <td>0.62</td> </tr> <tr> <td>18'</td> <td>8'</td> <td>17</td> <td>0.28</td> <td>19</td> <td>0.34</td> </tr> <tr> <td>22'</td> <td>10'</td> <td>11</td> <td>0.17</td> <td>12</td> <td>0.21</td> </tr> <tr> <td colspan="2">Delivered Illuminance Rating: (DIR)</td> <td colspan="2">62 FC per W/Sq. Ft.</td> <td colspan="2">55 FC per W/Sq. Ft.</td> </tr> <tr> <td colspan="6">Recessed mounting Square rooms used for multiple units: RCR 3: Length & Width = Ceiling Ht. - 2.5' x 3.33 RCR 5: Length & Width = Ceiling Ht. - 2.5' x 2.00 * Average Footcandles at 2.5' Above Floor</td> </tr> </tbody> </table>	Ceiling Height	Fixture Spacing	RCR 3		RCR 5		FC *	W/Sq. Ft.	FC *	W/Sq. Ft.	14'	6'	31	0.50	34	0.62	18'	8'	17	0.28	19	0.34	22'	10'	11	0.17	12	0.21	Delivered Illuminance Rating: (DIR)		62 FC per W/Sq. Ft.		55 FC per W/Sq. Ft.		Recessed mounting Square rooms used for multiple units: RCR 3: Length & Width = Ceiling Ht. - 2.5' x 3.33 RCR 5: Length & Width = Ceiling Ht. - 2.5' x 2.00 * Average Footcandles at 2.5' Above Floor					
	Ceiling Height	Fixture Spacing	RCR 3				RCR 5																																					
			FC *		W/Sq. Ft.	FC *	W/Sq. Ft.																																					
	14'	6'	31		0.50	34	0.62																																					
	18'	8'	17		0.28	19	0.34																																					
	22'	10'	11		0.17	12	0.21																																					
	Delivered Illuminance Rating: (DIR)		62 FC per W/Sq. Ft.		55 FC per W/Sq. Ft.																																							
	Recessed mounting Square rooms used for multiple units: RCR 3: Length & Width = Ceiling Ht. - 2.5' x 3.33 RCR 5: Length & Width = Ceiling Ht. - 2.5' x 2.00 * Average Footcandles at 2.5' Above Floor																																											
	0° 2220	0° - 20° 630 47%	8' 35 fc 6.0' 14 fc																																									
	5° 2139	0° - 30° 992 74%	10' 22 fc 7.5' 9 fc																																									
15° 1559	0° - 40° 1169 87%	12' 15 fc 9.0' 6 fc																																										
25° 752	0° - 60° 1294 96%	14' 11 fc 10.4' 5 fc																																										
35° 252	0° - 80° 1343 100%	16' 9 fc 11.9' 4 fc																																										
45° 94	0° - 90° 1346 100%	20' 6 fc 14.9' 2 fc																																										
55° 51	Total 1347 100%	24' 4 fc 17.9' 2 fc																																										
90° 1		28' 3 fc 20.9' 1 fc																																										

Delivered Lumens: 1347
Luminaire Watts: 20.4
LER: 66.03

CP at 0° (Nadir): 2220
CRI: 80

Beam Angle: 41°
Spacing Ratio: 0.65

Lumen Multiplier: N/A, 30L only
CCT Multiplier: 27K x 0.96, 30K x 0.98, 40K x 1.04
27HK x 0.87, 30HK x 0.81

IF03SMx xx PC 835 030 DLWFGP MW - Shallow

CANDLEPOWER CURVE TEST SP-00765_2_M-30L	INTENSITY CANDELA 0° AZIMUTH	ZONAL LUMENS		SINGLE UNIT: PERFORMANCE DIRECT FOOTCANDLES BASED ON DOWNLIGHT ONLY				MULTIPLE UNITS: PERFORMANCE 80/50/20% REFLECTANCES INITIAL FOOTCANDLES AND WATTS PER SQUARE FOOT							
		0° - 10°	135	10%	Mounting Height AFF	FC at Center on Floor	Beam Diameter	FC at Beam Edge	Ceiling Height	Fixture Spacing	RCR 2		RCR 4		
	0°	1412	0° - 10°	135	10%	8'	22 fc	8.0'	8 fc	10'	6'	34	0.52	29	0.52
	5°	1402	0° - 20°	483	36%	10'	14 fc	10.0'	5 fc	14'	8'	20	0.30	13	0.22
	15°	1249	0° - 30°	860	63%	12'	10 fc	12.0'	4 fc	18'	10'	14	0.22	12	0.22
	25°	792	0° - 40°	1108	82%	14'	7 fc	14.0'	3 fc	Delivered Illuminance Rating: (DIR)		66 FC per W/Sq. Ft.		56 FC per W/Sq. Ft.	
	35°	370	0° - 60°	1310	97%	16'	6 fc	16.0'	2 fc	Recessed mounting Square rooms used for multiple units: RCR 2: Length & Width = Ceiling Ht. - 2.5' x 5.00 RCR 4: Length & Width = Ceiling Ht. - 2.5' x 2.50 * Average Footcandles at 2.5' Above Floor					
	45°	169	0° - 80°	1354	100%	20'	4 fc	20.0'	1 fc						
	55°	74	0° - 90°	1357	100%	24'	2 fc	24.1'	1 fc						
	90°	2	Total	1357	100%	28'	2 fc	28.1'	1 fc						

Delivered Lumens: 1357
Luminaire Watts: 20.4
LER: 66.52

CP at 0° (Nadir): 1412
CRI: 80

Beam Angle: 53°
Spacing Ratio: 0.84

Lumen Multiplier: N/A, 30L only
CCT Multiplier: 27K x 0.96, 30K x 0.98, 40K x 1.04
27HK x 0.87, 30HK x 0.81

IF03SMx xx PC 835 030 WW WF LW MW - Wall Wash, Shallow

CANDLEPOWER CURVE TEST SP-00850_M-30L	PERFORMANCE SUMMARY	REFERENCE DIAGRAM
--	---------------------	-------------------

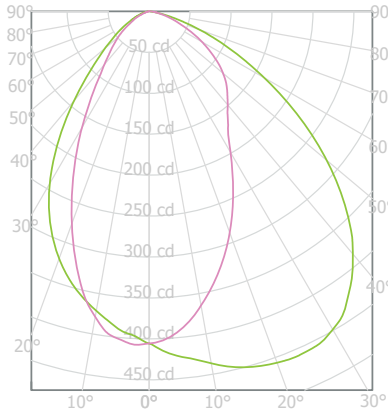

Delivered Lumens: 677
 Luminaire Watts: 20.4
 LER: 33.19
 CP at 0deg (Nadir): 406
 CRI: 80
 Lumen Multiplier: N/A, 30L only
 CCT Multiplier: 27K x 0.96, 30K x 0.98, 40K x 1.04
 27HK x 0.87, 30HK x 0.81

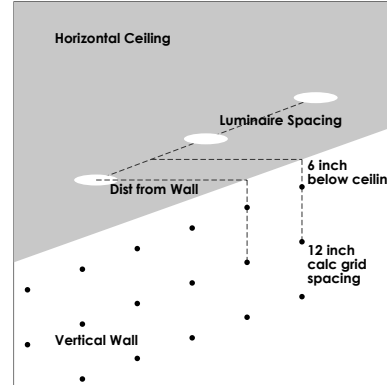

PERFORMANCE DATA - INITIAL ILLUMINATION (FOOTCANDLES) ON WALL - DIRECT LIGHT ONLY

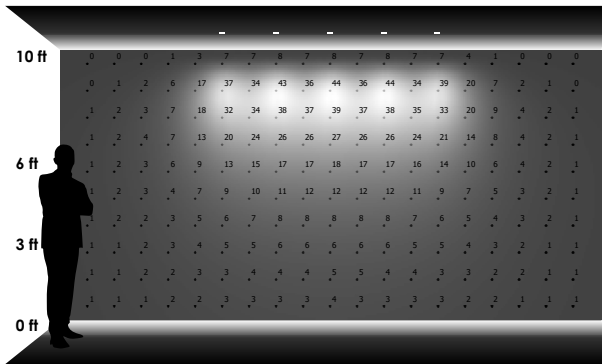

5 LUMINAIRES
 2' away from wall
 2' between luminaires

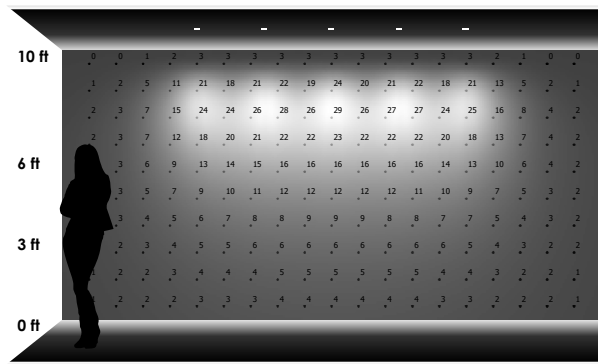

5 LUMINAIRES
 2'-6" away from wall
 2'-6" between luminaires

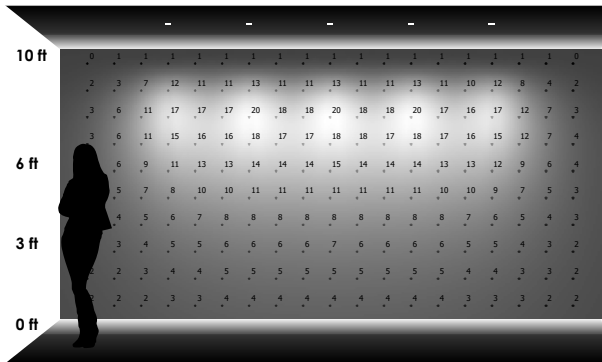

5 LUMINAIRES
 3' away from wall
 3' between luminaires

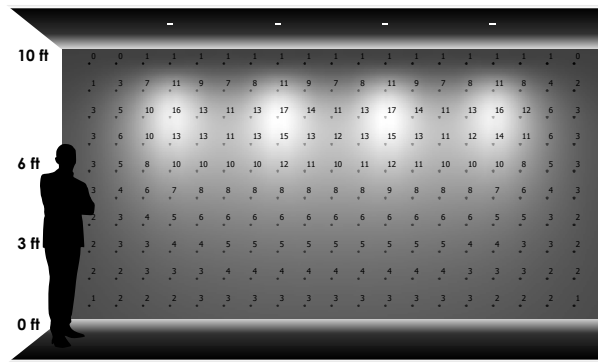

4 LUMINAIRES
 3' away from wall
 4' between luminaires

IF03SSx IC 835 015 N11 DLSPGP MW - Super Shallow

CANDLEPOWER CURVE TEST SP-00780_2_M-015L	INTENSITY CANDELA 0° AZIMUTH	ZONAL LUMENS	SINGLE UNIT: PERFORMANCE INITIAL FOOTCANDLES BASED ON IES BEAM ANGLE				MULTIPLE UNITS: PERFORMANCE 80/50/20% REFLECTANCES INITIAL FOOTCANDLES AND WATTS PER SQUARE FOOT								
			Mounting Height AFF	FC at Center on Floor	Beam Diameter	FC at Beam Edge	Ceiling Height	Fixture Spacing	RCR 3		RCR 5				
	0.00°														
	0.00°	2,247	0° - 10°	172	24%	5.5'	74 fc	2.5'	37 fc	9'	2'	184	2.63	136	2.17
	5.00°	1,930	0° - 20°	429	59%	6.5'	53 fc	2.9'	27 fc	12'	4'	46	0.65	44	0.71
	10.00°	1,376	0° - 30°	601	82%	7.5'	40 fc	3.4'	20 fc	16'	6'	23	0.32	22	0.35
	15.00°	941	0° - 40°	661	90%	8.5'	31 fc	3.9'	16 fc	Delivered Illuminance Rating: (DIR)		70 FC per W/Sq. Ft.		63 FC per W/Sq. Ft.	
	20.00°	610	0° - 60°	705	97%	10.0'	22 fc	4.5'	11 fc	Recessed Mounting Square rooms used for multiple units: - RCR 3: Length & Width = Ceiling Ht. -2.5' x 3.33 - RCR 5: Length & Width = Ceiling Ht. -2.5' x 2.00 + Average Footcandles at 2.5' Above Floor					
	30.00°	161	0° - 80°	729	100%	12.0'	16 fc	5.4'	8 fc						
	40.00°	27	0° - 90°	730	100%	14.0'	11 fc	6.4'	6 fc						
	50.00°	22	Total	730	100%	16.0'	9 fc	7.3'	4 fc						
	60.00°	25													
	70.00°	12													
	80.00°	4													
90.00°	1														

Delivered Lumens: 730
Luminaire Watts: 10.2
LER: 71.57

CP at 0deg (Nadir): 2,247
CRI: 80

Beam Angle: 25.31
Spacing Ratio: 0.42

Lumen Multiplier: 07L x 0.40, 10L x 0.56
CCT Multiplier: 27K x 0.95, 30K x 0.98, 40K x 1.03

IF03SSx IC 835 015 N11 DLNFGP MW - Super Shallow

CANDLEPOWER CURVE TEST SP-00779_2_M-015L	INTENSITY CANDELA 0° AZIMUTH	ZONAL LUMENS	SINGLE UNIT: PERFORMANCE INITIAL FOOTCANDLES BASED ON IES BEAM ANGLE				MULTIPLE UNITS: PERFORMANCE 80/50/20% REFLECTANCES INITIAL FOOTCANDLES AND WATTS PER SQUARE FOOT								
			Mounting Height AFF	FC at Center on Floor	Beam Diameter	FC at Beam Edge	Ceiling Height	Fixture Spacing	RCR 3		RCR 5				
	0.00°														
	0.00°	1,799	0° - 10°	150	21%	5.5'	59 fc	3.1'	30 fc	9'	2'	150	2.18	134	2.17
	5.00°	1,664	0° - 20°	409	56%	6.5'	43 fc	3.7'	21 fc	12'	4'	45	0.65	44	0.71
	10.00°	1,331	0° - 30°	592	82%	7.5'	32 fc	4.3'	16 fc	16'	6'	17	0.25	14	0.22
	15.00°	950	0° - 40°	659	91%	8.5'	25 fc	4.8'	12 fc	Delivered Illuminance Rating: (DIR)		69 FC per W/Sq. Ft.		62 FC per W/Sq. Ft.	
	20.00°	636	0° - 60°	700	97%	10.0'	18 fc	5.7'	9 fc	Recessed Mounting Square rooms used for multiple units: - RCR 3: Length & Width = Ceiling Ht. -2.5' x 3.33 - RCR 5: Length & Width = Ceiling Ht. -2.5' x 2.00 + Average Footcandles at 2.5' Above Floor					
	30.00°	186	0° - 80°	722	100%	12.0'	12 fc	6.8'	6 fc						
	40.00°	35	0° - 90°	724	100%	14.0'	9 fc	8.0'	5 fc						
	50.00°	19	Total	724	100%	16.0'	7 fc	9.1'	4 fc						
	60.00°	17													
	70.00°	13													
	80.00°	5													
90.00°	1														

Delivered Lumens: 724
Luminaire Watts: 10.2
LER: 70.98

CP at 0deg (Nadir): 1,799
CRI: 80

Beam Angle: 31.46
Spacing Ratio: 0.51

Lumen Multiplier: 07L x 0.40, 10L x 0.56
CCT Multiplier: 27K x 0.95, 30K x 0.98, 40K x 1.03

IF03SSx IC 835 015 N11 DLFLGP MW - Super Shallow

CANDLEPOWER CURVE TEST SP-00778_2_M-015L	INTENSITY CANDELA 0° AZIMUTH	ZONAL LUMENS	SINGLE UNIT: PERFORMANCE INITIAL FOOTCANDLES BASED ON IES BEAM ANGLE				MULTIPLE UNITS: PERFORMANCE 80/50/20% REFLECTANCES INITIAL FOOTCANDLES AND WATTS PER SQUARE FOOT								
			Mounting Height AFF	FC at Center on Floor	Beam Diameter	FC at Beam Edge	Ceiling Height	Fixture Spacing	RCR 3		RCR 5				
	0.00°														
	0.00°	1,154	0° - 10°	104	15%	5.5'	38 fc	4.1'	19 fc	9'	4'	35	0.54	31	0.54
	5.00°	1,112	0° - 20°	328	47%	6.5'	27 fc	4.9'	14 fc	12'	4'	43	0.65	26	0.45
	10.00°	990	0° - 30°	516	74%	7.5'	21 fc	5.6'	10 fc	16'	6'	16	0.25	13	0.22
	15.00°	811	0° - 40°	608	87%	8.5'	16 fc	6.3'	8 fc	Delivered Illuminance Rating: (DIR)		65 FC per W/Sq. Ft.		57 FC per W/Sq. Ft.	
	20.00°	597	0° - 60°	673	96%	10.0'	12 fc	7.5'	6 fc	Recessed Mounting Square rooms used for multiple units: - RCR 3: Length & Width = Ceiling Ht. -2.5' x 3.33 - RCR 5: Length & Width = Ceiling Ht. -2.5' x 2.00 + Average Footcandles at 2.5' Above Floor					
	30.00°	233	0° - 80°	698	100%	12.0'	8 fc	9.0'	4 fc						
	40.00°	77	0° - 90°	700	100%	14.0'	6 fc	10.4'	3 fc						
	50.00°	33	Total	700	100%	16.0'	5 fc	11.9'	2 fc						
	60.00°	22													
	70.00°	15													
	80.00°	5													
90.00°	1														

Delivered Lumens: 700
Luminaire Watts: 10.2
LER: 68.63

CP at 0deg (Nadir): 1,154
CRI: 80

Beam Angle: 40.91
Spacing Ratio: 0.65

Lumen Multiplier: 07L x 0.40, 10L x 0.56
CCT Multiplier: 27K x 0.95, 30K x 0.98, 40K x 1.03

IF03Sx IC 835 015 N11 DLWFGP MW - Super Shallow

CANDLEPOWER CURVE
TEST SP-00781_2_M-015L

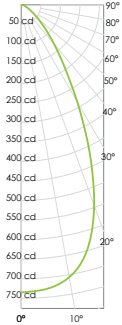

INTENSITY CANDELA
0° AZIMUTH

0.00°		
0.00°	734	
5.00°	729	
10.00°	706	
15.00°	649	
20.00°	545	
30.00°	287	
40.00°	131	
50.00°	59	
60.00°	25	
70.00°	11	
80.00°	3	
90.00°	1	

ZONAL LUMENS

0° - 10°	70	10%
0° - 20°	251	36%
0° - 30°	447	63%
0° - 40°	576	82%
0° - 60°	681	97%
0° - 80°	704	100%
0° - 90°	706	100%
Total	706	100%

SINGLE UNIT: PERFORMANCE
INITIAL FOOTCANDLES
BASED ON IES BEAM ANGLE

Mounting Height AFF	FC at Center on Floor	Beam Diameter	FC at Beam Edge
5.5'	24 fc	5.5'	12 fc
6.5'	17 fc	6.5'	9 fc
7.5'	13 fc	7.5'	6 fc
8.5'	10 fc	8.5'	5 fc
10.0'	7 fc	10.0'	4 fc
12.0'	5 fc	12.0'	3 fc
14.0'	4 fc	14.0'	2 fc
16.0'	3 fc	16.0'	1 fc

MULTIPLE UNITS: PERFORMANCE
80/50/20% REFLECTANCES
INITIAL FOOTCANDLES AND WATTS PER SQUARE FOOT

Ceiling Height	Fixture Spacing	RCR 2		RCR 4	
		FC +	W/Sq. Ft.	FC +	W/Sq. Ft.
9'	4'	43	0.62	37	0.62
12'	6'	20	0.29	17	0.29
16'	8'	10	0.14	9	0.14
Delivered Illuminance Rating: (DIR)		69 FC per W/Sq. Ft.		60 FC per W/Sq. Ft.	
Recessed Mounting Square rooms used for multiple units: - RCR 2: Length & Width = Ceiling Ht. - 2.5' x 5.00 - RCR 4: Length & Width = Ceiling Ht. - 2.5' x 2.50 + Average Footcandles at 2.5' Above Floor					

Delivered Lumens: **706**
Luminaire Watts: **10.2**
LER: **69.22**

CP at 0deg (Nadir): **734**
CRI: **80**

Beam Angle: **53.33**
Spacing Ratio: **0.84**

Lumen Multiplier: **07L x 0.40, 10L x 0.56**
CCT Multiplier: **27K x 0.95, 30K x 0.98, 40K x 1.03**

IF03SSx xx PC 835 015 WW WF LW MW - Wall Wash, Shallow

CANDLEPOWER CURVE
TEST SP-00898_M-015L

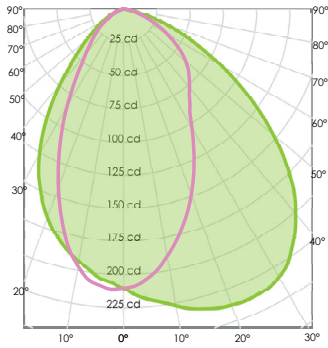

PERFORMANCE SUMMARY

Delivered Lumens: 352
 Luminaire Watts: 10.2
 LER: 34.51
 CP at 0deg (Nadir): 211
 CRI: 80+
 Lumen Multiplier: 07L x 0.4, 10L x 0.56
 CCT Multiplier: 27K x 0.95, 30K x 0.98, 40K x 1.03

REFERENCE DIAGRAM

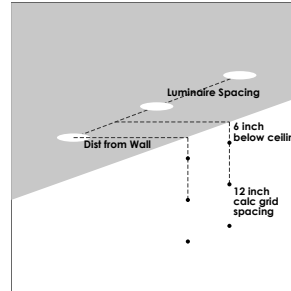

PERFORMANCE DATA - INITIAL ILLUMINATION (FOOTCANDLES) ON WALL - DIRECT LIGHT ONLY

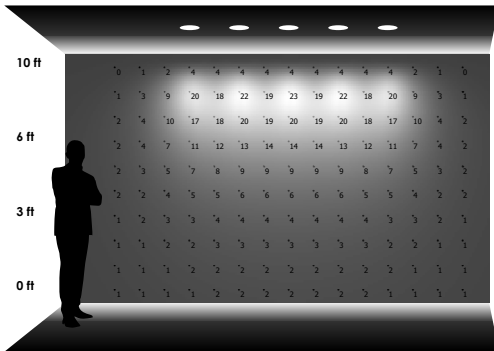

5 LUMINAIRES
2' away from wall
2' between luminaires

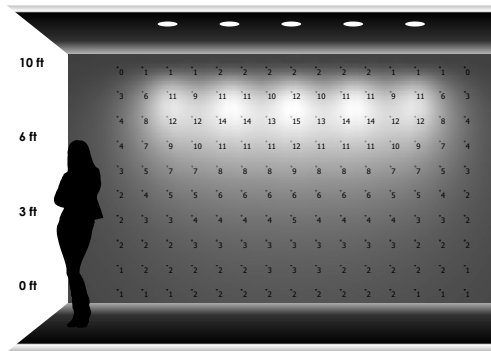

5 LUMINAIRES
2'-6" away from wall
2'-6" between luminaires

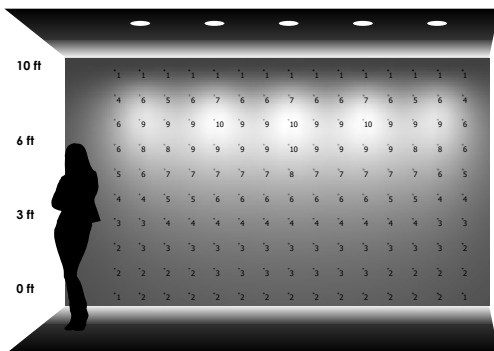

5 LUMINAIRES
3' away from wall
3' between luminaires

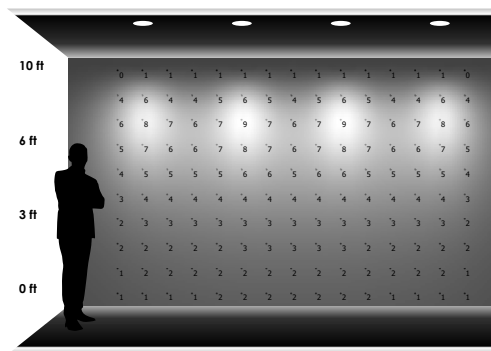

4 LUMINAIRES
3' away from wall
4' between luminaires